



MADSEN'S™

2025

The Pro's Choice



MADSENS Hooded Sweatshirts

Youth Hooded Sweatshirts

Style #PC90H

Size: M-XL **\$19.95**

Grey or Black

Adult Hooded Sweatshirts

Style #12500

Size: S-XL **\$35.95**

Grey or Black

Style #PC90HT

Size: Tall-3Xlt **\$39.95**

Grey or Black

MADSENS



Ceramic Logo Mug

\$14.99



14oz Double Wall Stainless Steel Vacuum Mug w/ Lid

\$25.99



MADSENS Logo Caps

Limited Supply

Trucker Cap Patch **\$29.95**

Liquid Logo Green or Burgandy **\$34.95**

Map to Madsen's

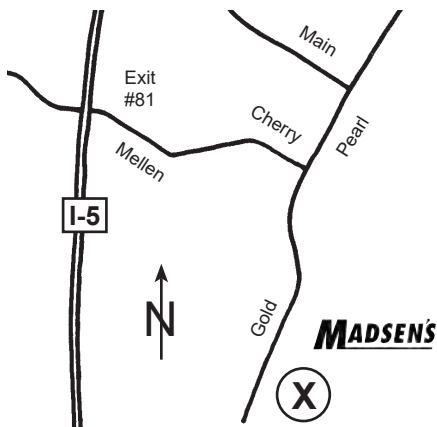

How to Buy from Madsen's

Shipping. Packages going to an address in the lower forty-eight states are usually sent via UPS. Sometimes we can save by sending small items via the US Post Office flat rate, but UPS often offers the most reasonable rate. Packages sent to Alaska are usually sent via First Class Priority Air Mail unless otherwise requested. Service to Alaska's mainland is usually two working days. Delivery to an island in Alaska depends on flying weather, but it is surprisingly good. USPS has ground advantage (parcel post) which also may save money.

Catalog Pricing. The prices in this catalog reflect our costs when it was printed. Some prices may change before we print another one, so to be sure about a price, call us. Also, watch your mailbox for sale flyers. Products in flyers are usually priced even less than those in this catalog. If you have a question – about prices, your bill, or anything – please call us. We will do our best to offer you good service and value. We want to be your supplier for life.

Paying for Merchandise. We accept the usual methods of payment, which includes:



For More Info:
360-736-1336

The cover photo was taken by Kevin Core of Logger's World Publications.

Inside...

Alaskan saw mill.....	84-85
Axes and handles.....	5-6
Bars and tips	88-91
Boots	64-72
Chain, saw.....	92-93
Chaps, safety	27-28
Climbing gear	13-19
Coats and jackets.....	29-37
Ear plugs and protection	20-21
Files	100
Fire tools.....	8
First aid.....	22
Flagging and tree paint	12
Glasses, safety.....	23-24
Gloves	57-59
Hats and caps	25-26, 37, 39
Measuring tools	9-11
Pants and jeans.....	42-45
Rain gear.....	35-37
Repair, saw tools.....	79-83
Safety wear	31-34
Sharpening tools	95-99
Shirts	31-33, 46-51
Socks.....	73-76
Splitter, log.....	103
Suspenders	55-56
Tapes.....	10-11
Underwear.....	40-41
Wedges, faller's.....	1-3
Winches.....	86-87

☎

Visit Us

Madsen's Shop & Supply Inc.
1408 South Gold Street #2
Centralia WA 98531

Contact Us

(360) 736-1336 Main Business Line
(800) 822-2808 Out-of-State Order Line
(360) 736-9522 FAX Order Line Email
Orders office@madsensl.com
www.madsensl.com

Hours

8AM to 6PM Mon to Fri
8AM to 3PM Sat
Closed Sunday



Double Taper Wedges

Double Taper wedges are made of hard and durable ABS plastic. This makes them good all-weather wedges. Their yellow body and bright orange top makes them easy to see and retrieve from the debris after a tree falls. Madsen's has carried DOUBLE TAPER brand faller's wedges since 1963. They have been the first choice of timber fallers for over fifty years.

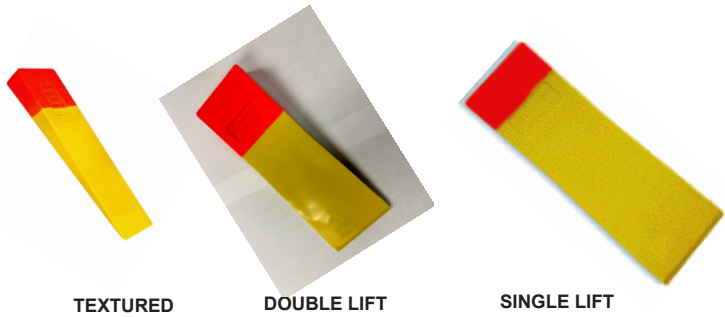

Part #	Length	Lift Rate	Description/Type	List Price	MADSEN'S PRICE		
					1-11 ea	12-47 ea	48+ ea

Double Taper™

Standard Double Taper wedges are durable all-season wedges.

#59-A	5½"	18%	Textured.....	4⁹⁶	4²⁵	3 ⁹⁰	3 ⁶⁰
#97-A	7"	18%	Double Lift - Smooth.....	9⁶⁰	8²⁵	7 ⁴⁵	6 ⁹⁵
#98-A	8"	16%	Smooth	8⁷⁴	7⁵⁰	6 ⁷⁵	6 ³⁵
#100-A	10"	10%	Smooth	9⁶⁰	8¹⁵	7 ³⁵	6 ⁹⁵
#110-A	10"	12%	Double Lift - Smooth.....	10⁷⁰	8⁹⁵	8 ²⁰	7 ⁸⁰
#111-A	10"	13%	Textured.....	10⁹⁰	9¹⁰	8 ²⁵	7 ⁹⁰
#112-AS	12"	11%	Smooth	14¹⁶	11⁹⁵	10 ⁷⁵	10 ²⁵
#112-AT	12"	11%	Textured.....	14¹⁶	11⁹⁵	10 ⁷⁵	10 ²⁵
#114-A	12"	9%	Extra Wide - Smooth	14⁸⁴	12⁵⁵	11 ³⁵	10 ⁷⁵
#115-A*	15"	11%	Smooth	18⁸⁶	15⁹⁵	14 ⁴⁵	13 ⁶⁵

*Note: The 15" wedge has a unique rounded tip and extra lift. In addition to its use as a wedge in large trees, it's often used as a hammer for setting smaller wedges.

Double Taper™ Red-Top

The Double Taper Red-Top wedge has a white body and red top. It is colored much like a K & H wedge.

#96-AW	8"	18%	Textured	8⁸⁵	6⁹⁵	6 ⁴⁰	5 ⁹⁵
--------	----	-----	----------------	---------------------------	-----------------------	-----------------	-----------------

Info on Lift Rate % & Wedge Surfaces

Lift Rate: Most Double Taper wedges lift between 1" and 1.5". In most cases, shorter wedges lift at the fastest rate. The column showing % lift, indicates the lift rate of each wedge. The larger the number is, the faster it lifts. The lower the number, the slower it lifts, which is often a benefit when lifting a heavy tree.

Surface Texture: Some Double Taper wedges are smooth on the outside and some are textured. Wedges with smooth surfaces drive the easiest, but textured wedges often hold better in a tree.



MADSEN'S Wedges

MADSEN'S wedges are made of hi-impact ABS plastic wedges by the same people who makes the legendary Double Taper brand wedges. These wedges are excellent quality and value priced.

Part #	Size	% Lift	Description	List Price	MADSEN'S PRICE		
					1-11 ea	12-47 ea	48+ ea
Blue Ox - Single Lift - Hard - Blue Plastic							
# 8B-WGM	8"	13%	Lightly Textured	8⁹⁵	5⁶⁵	5 ⁷⁰	5 ²⁵
#10B-WGM	10"	12%	Lightly Textured	11⁹⁵	7⁸⁵	7 ⁴⁰	7 ¹⁵
#12B-WGM	12"	11%	Lightly Textured	14⁸⁵	10⁷⁵	9 ⁵⁵	8 ¹⁵
Blaze Pro - Single Lift - Hard - Fluorescent Orange Plastic							
#OFL-96M	8"	17%	Lightly Textured	6⁷⁵	6²⁵	5 ⁷⁰	5 ²⁵
#OFL-105M	10"	10%	Lightly Textured	11⁹⁵	7²⁵	7 ⁴⁰	7 ¹⁵
#OFL-112M	12"	11%	Lightly Textured	14⁹⁵	10⁷⁵	9 ⁹⁵	8 ¹⁵

Black Bear Rifled Faller's Wedges

Timber Fallers: How many times have you had a tree sit back because the stack of wedges you were driving twisted?

BLACK BEAR WEDGES were designed by a timber faller. Each wedge has a pair of grooves and matching rails to keep them aligned when they are stacked. This overcomes the problem conventional wedges have of skewing sideways at a crucial time.



Black Bear Wedges help:

- Save time
- Increase productivity
- Make tree work safer
- Aid tree placement

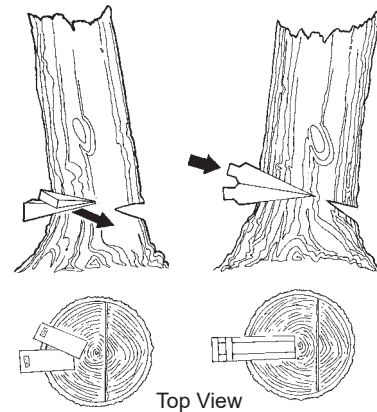

Top View

Part #	Size	% Lift	Description	List Price	MADSEN'S PRICE		
					1-11 ea	12-47 ea	48+ ea
Black Bear - Single Lift - Hard - Yellow ABS Plastic							
#8-BEAR	8"	17%	Smooth	9⁴⁵	7⁹⁵	7 ²⁵	6 ⁸⁵
#10-BEAR	10"	14%	Smooth	10⁸⁵	8⁷⁵	8 ¹⁵	7 ⁸⁰
#12-BEAR	12"	11%	Smooth	14⁵⁵	11⁶⁵	10 ⁹⁵	10 ⁴⁵



K & H Wedges



K&H faller's wedges are known for being easy to drive and having great lifting power.

Size	% Lift	Description	List Price	MADSEN'S PRICE		
				1-11 ea	12-47 ea	48+ ea
K&H - Single Lift - Hard - White Plastic with a Red Top						
7 1/2"	17%	Lightly Textured	9⁵⁸	7⁹⁵	7 ²⁵	6 ⁸⁵
10"	10%	Lightly Textured	10⁸⁵	8⁶⁵	7 ⁸⁵	7 ⁴⁵
12"	8%	Lightly Textured	13⁰⁰	10⁹⁵	9 ⁸⁵	9 ³⁵

Hard Head Wedges

HARD HEAD WEDGES are made of ABS plastic and have a hard metal head molded into the body.

Size	% Lift	Description	List Price	MADSEN'S PRICE		
				1-11 ea	12-47 ea	48+ ea
Hard Head - Single Lift - Hard - White Plastic with a Red Metal Top						
8"	12%	Lightly Textured	18⁹⁵	15²⁵	14 ²⁵	13 ²⁵
10"	14%	Lightly Textured	22⁷⁵	18²⁵	17 ²⁵	16 ²⁵
12"	9%	Lightly Textured	23³⁵	19⁹⁵	18 ⁴⁵	17 ⁴⁵

Wedge Pouches

We carry two types of WEDGE POUCHES: one is a leather pouch, the other is made of tough Cordura nylon. Both pouches are the same size and have space for two or three wedges and a file or bar tool.

Leather Pouch
List ~~35⁰⁰~~
MADSEN'S
1-5 **32⁹⁵**
6+ **31⁹⁵**
Item #P100

Nylon Pouch
List ~~19⁹⁵~~
MADSEN'S
1-5 **16⁹⁵**
6+ **16⁵⁰**
Item #WP500



Utility Belts

UTILITY BELTS are tough and adjustable. They work great with a wedge pouch, a fire extinguisher pouch, or an axe scabbard.



MADSEN'S PRICE
Web Belt w/ Grommets Item #UB **15⁹⁵**
Leather Belt w/ Grommets..... **19⁹⁵**
Super-Duty Leather 32"-46" Item #465BLK.... **43⁹⁵**

Hi-Jacker Tree Jack

Timber fallers know timberland owners won't stand for logs being broken in the felling process. They also know loggers expect logs to lay in a pattern that allows them to be moved efficiently. Environmental regulation presents yet another challenge as logs and debris can't land in sensitive riparian areas. On top of it all, a timber faller must manipulate the powerful forces of gravity and leverage safely. All of this is what makes a chain-saw operator a timber-faller.

Much of the time, wedges provide a timber-faller with the lift he needs to direct a tree into a good lay. However, in some forests, so much lifting is necessary, its not feasible to do with only wedges. This is when having a tree jack (and the skill to use it) is important.

Hi-Jacker Benefits

The Hi-Jacker is super-powerful for its size and weight. Unlike pack-style tree jacks, which have components that are coupled by hoses, the Hi-Jacker is self-contained. The ram, pump, and oil reservoir are an all-in-one unit. This means there are no fittings to clean or hoses to maintain. This all-in-one design has another advantage. Without hoses, a Hi-Jacker can operate at higher internal pressures. As a result, on a pound-per-pound basis, the Hi-Jacker out-lifts all older pack-style designs.

The Hi-Jacker is a clone of Silvey's Hi-Jacker (no longer made), with a few improvements. These include a steel gauge-protector and a removable handle for easy transport. The Hi-Jacker is made in the USA by Salt Creek Industries, the folks who make the Simington chain grinder. Most parts are CNC machined, so the fit and finish is excellent.

Application

The Hi-Jacker doesn't have the brute force of a big Silvey Tree Saver pack-style jack-set, but it offers plenty of lift for most second-growth cutting jobs. The Hi-Jacker's compact and light-weight design makes it easy to carry, while its small size makes cutting a jack-seat quick and easy. It is ideal for working in much of today's smaller timber.

WARNING: Don't use a tree jack unless you have had special training and jacking experience.



MADSEN'S PRICE

2449⁰⁰

Hi-Jacker™ Self-Contained Ram Unit

Lift Capacity:	45 Tons
Lift Height:	4"
Cylinder Diameter:	3"
Pack Weight:	27 lbs
Oil Capacity:	1 Pint
Hose Length:	No Hoses Needed



Pictured Above: A tree jack in its seat on a nice second growth tree. A few pumps on the handle and this tree fell right where it was supposed to.

Council Faller's Axe













The COUNCIL FALLER'S AXE features a head with a narrow-ground bit for chopping, thick cheeks for strength, and a finish-ground poll (heel) for driving plastic wedges. It is made from American bar quality steel, but patterned from a European style, so you might find them a little heavy for their weight classification. It is also drop forged, heat treated, and ground making it an excellent value.

Axe Type	Handle	List	MADSEN'S	
			1-5 ea	6 +ea
3.5 lb Axe with 20" handle		68⁶⁵	55⁹⁵	54 ⁵⁰
4 lb Axe with 28" handle		82⁴⁶	68⁹⁵	67 ⁵⁰
5 lb Axe with 28" handle		95²⁸	77⁹⁵	76 ⁵⁰

Hickory Handles

These HANDLES are made from HICKORY, a tough and dense wood from which the finest tool handles are made. They are durable, yet absorb some of the vibration created when a striking tool is used for chopping or pounding.

Type	Length & Description	Part Number	List Price	MADSEN'S	
				1-11	12+
	28" boys, single bit curved	#298	18³⁵	14⁵⁰	13 ⁵⁰
	36" axe, single bit curved	#289	18³⁵	14⁵⁰	13 ⁵⁰
	28" axe, fits 4# & 5# Council	#282	18³⁵	14⁵⁰	13 ⁵⁰
	36" axe, fits 6# Council	#362	18³⁵	14⁵⁰	13 ⁵⁰
	28" cruiser, double bit	#281	18³⁵	14⁵⁰	13 ⁵⁰
	36" crown, double bit	#279	18³⁵	14⁵⁰	13 ⁵⁰
	30" sledge	#251	18³⁵	14⁵⁰	13 ⁵⁰
	36" sledge	#253	18³⁵	14⁵⁰	13 ⁵⁰
	36" heavy sledge	#257	18³⁵	14⁵⁰	13 ⁵⁰
	36" maul axe eye	#362	18³⁵	14⁵⁰	13 ⁵⁰
	54" peavey	#1628	79⁹⁵	64⁹⁵	

Axe handles come with wood mounting wedges only. Extra wood mounting wedges are 35¢ each. Metal mounting wedges are 45¢ each and come in two sizes: small & medium.

Fallers/Rafting Axe Handles



TUNE YOUR AXE to your body – just pick the handle length that best fits your swing and axe head weight. All custom handles are straight single-bit style. They are made from premium grade hickory for maximum strength and durability. They are available in the following lengths: 20", 26", 28", 30", 32", & 36".

Length	Part#
20"	#283
26"	#426
28"	#282
30"	#430
32"	#432
36"	#362

MADSEN'S	
1-11	14⁵⁰
12+	13⁵⁰

Aluminum Axe Scabbard

The AXE SCABBARD is light-weight and tough. It allows you to safely transport an axe, yet keeps it handy for when you need it. The scabbard's design features open corners, which helps it stay clear of dirt and sawdust. Fitting Instructions: Axe should be about 1/8" smaller than the scabbard to go into and out-of the scabbard smoothly and freely.

Axe Size **MADSEN'S**

- #6 Fits 3-3½ lb.....**21⁶⁰**
- #7 Fits 4 lb.....**22⁴⁵**
- #8 Fits 5 lb.....**23³⁰**
- #9 Fits 6 lb.....**24⁶⁰**



Shoulder Pad & Belt System

The SHOULDER PAD & BELT SYSTEM was developed by a timber faller to distribute the weight of an axe and wedges to your shoulders. This takes weight off your hips, which makes transporting tools easier and more comfortable. It features leather pads and a belt (not included) - all connected by nylon straps. Belt sold separately.

Belt Length: S-39", M-43", L-47", XL-50". Fitting Instructions: The length shown is total belt length, not waist size. Buy a size ten to twelve inches larger than your waist measurement to allow for overlap and clothing.

Item **MADSEN'S**

- Shoulder Pads.....**30⁹⁵**
- Leather Belt**19⁹⁵**

Byte Tyte Chainsaw Scabbard Mount

The BYTE TYTE allows a ready-to-run chain-saw to be safely transported on a 4-wheeler, snowmobile, tractor, or any type of equipment. Forget elastic cords that are slow to use and eventually get cut by the saw chain. With a Byte Tyte, simply slide the saw's bar into the opening, then turn the screw-clamp to hold it in place. When you are ready to use the chain-saw, a reverse turn of the clamp releases it just as quickly.

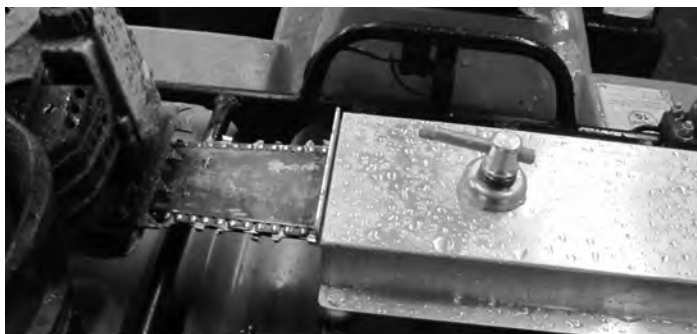

A Byte Tyte should be fitted to the saw it carries. Custom lengths are available by special order. An open ended version is also available.

The Byte Tyte's all-aluminum construction does not damage the saw's chain. At the same time, it protects the area around the saw's chain from being damaged by it.

Item	List	MADSEN'S
16" Scabbard	70⁵⁰	73⁵⁰
20" Scabbard	71⁵⁰	77⁵⁰
24" Scabbard	73⁵⁰	79⁵⁰
30" Scabbard	82⁵⁰	89⁵⁰
Open Ended	44⁵⁰	49⁵⁰

Shovel & Hand Tools



HOOKAROON
36" curved handle

List ~~74⁹⁵~~
MADSEN'S
1-5 **61⁹⁵**
6+ **60⁵⁰**



PEAVEY
54" handle

List ~~189⁹⁵~~
MADSEN'S
1-5 **169⁹⁵**



MACHETE BRUSH SICKLE
with hand-grip with hand-grip

List ~~15⁵⁰~~ List ~~27⁹⁵~~
MADSEN'S MADSEN'S
1-5 **9⁹⁵** 1-5 **22⁹⁵**
6+ **8⁹⁵** 6+ **17⁹⁵**



INDIAN 5-GALLON COLLAPSABLE BACK PACK PUMP Style# 85220
\$309.95

*Yellow vinyl tank bag
*Brass, hand-operated pump
*1/4" I.D. hose and padded shoulder straps. Weighs 4-1/2lbs
*Separate grommets for carry handle and backpack straps



INDIAN 5-Gallon Backpack Fire Pump

* Form-fitting galvanized steel tank, ventilated to give constant circulation of air between tank and carrier's back
*Solid brass pump throws a powerful 30 to 40 ft. stream of water
*Easy to operate: quickly filled through its 4 in. filler opening
*27 in. hose
*Weight 11 lbs. when empty
*5 Gallon capacity

List ~~318⁹⁵~~
MADSEN'S
299⁹⁵

Fire Extinguisher

The SMALL FIRE EXTINGUISHER is a safe, clean, and fast way to suppress a small wood, paper, liquid, or grease fire. It is not for use on electrical fires. No shaking is necessary and its non-powder agent is non-toxic, biodegradable, and environmentally safe. Contains 16 oz.

The extinguisher and pouch are sold separately.

List ~~22⁹⁵~~
MADSEN'S
1-11 **19⁵⁰**
12+ **18⁵⁰**

Extinguisher Pouch



The EXTINGUISHER POUCH is made of tough Cordura nylon. It has a belt-loop attachment for easy carrying. Item #P500S.

List ~~19⁹⁵~~
MADSEN'S
1-11 **17⁹⁵**
12+ **16⁹⁵**

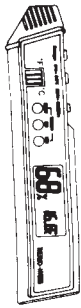

Humidity Tester

Test humidity easily with this battery-operated thermometer/hygrometer. No more slinging thermometers or wetted wicks. This hand-held tester measures temperature and humidity with a simple touch of a button.

List Price ~~95⁰⁰~~
MADSEN'S 89⁹⁹

Item #490-76255

Hand Tally Counter

The HAND COUNTER is a 4-digit model with a wire finger ring. Counter is easily reset with one turn of the knob and is easy to read.



List Price ~~13⁰⁰~~
MADSEN'S 10⁹⁵

"Rite in the Rain"® Notebooks



NOTEBOOKS contain 50 lined pages and are spiral bound. They fit easily in a large shirt or hip pocket. Notebooks work great for keeping track of scale or other records.



N/A AT THIS TIME



Shirt Pocket Size
 List ~~5²⁵~~
MADSEN'S
 1-11 **4⁴⁵**
 12+ **4⁰⁵**

Hip Pocket Size
 List ~~6⁷⁵~~
MADSEN'S
 1-11 **5⁴⁵**
 12+ **4⁸⁵**

Hip Chain

NOT AVAILABLE AT THIS TIME

The HIP CHAIN attaches to your belt and measures distance as you walk. Just tie the string to a tree, set the meter at zero and walk. Your hands are free and there is no tape to tangle up. There is approximately 4500' of string on a roll. Item #350-138



List Price ~~170⁰⁰~~
MADSEN'S
139⁹⁵

Extra White String **4⁹⁵**



Suunto Navigator Compass



List Price ~~79⁰⁰~~
MADSEN'S 69⁹⁹

The SUUNTO NAVIGATOR COMPASS is a good compass for a forester or land owner. It has quadrant 0-90 or Azimuth 0-360 graduations and adjustable declination. This allows you to adjust for the difference between magnetic north and true north. Its large mirror enhances accuracy when sighting on distant land-marks. A built-in clinometer lets you measure inclination. It features a liquid-damped magnetic steel needle and long-lasting precision pivot. Item #37182 0-360 degree Azimuth
 Item #37183 0-90 degree Quadrant



belt loop
 Item #0003



Key Bak

spring clip
 Item #0005

Keep your keys or crayon holder handy with a KEY BAK. It is available with either a spring clip or belt loop so you can hook 'em on your suspenders or jeans.

List ~~15⁶⁵~~
MADSEN'S
 1-11 **10⁵⁰**
 12+ **9⁸⁰**

Automatic Logger's Measuring Tape

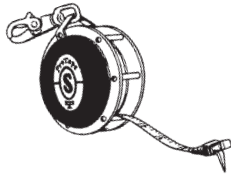

Spencer Logger's Tapes

SPENCER automatic tapes are the industry standard for loggers, engineers, and foresters.



Model #	Length	Description	MADSEN'S PRICE		
			List Price	1-5 ea	6+ea
# 950	50'	Traditional Logger's Tape - auto gear drive Blade top: feet, inches, eighths of inches Blade bottom: feet, inches, eighths of inches	64⁰⁰	42⁹⁵	40 ⁹⁵
# 950DC	50'	Logger's Tape for Measuring Tree Diameter Blade top: feet and tenths of feet Blade bottom: diameter in feet and tenths	72⁹⁵	52⁹⁵	50 ⁹⁵
# 950XL	65'	Same Size as #950 - with metric on bottom Blade top: feet, inches, eighths of inches Blade bottom: meters, centimeters	82⁰⁰	49⁹⁵	47 ⁹⁵
# 975	75'	Big Version of the #950 - automatic gear drive Blade top: feet, inches, eighths of inches Blade bottom: feet, inches, eighths of inches	88⁰⁰	55⁹⁵	53 ⁹⁵

Tape Refills, Repair Ends, & Nails

Item Image	Description	MADSEN'S PRICE		
		List Price	1-5 ea	6+ea
	50' Refill Feet/Feet Standard	18⁹⁵	13⁹⁵	12 ⁵⁰
	50' Refill Diameter/Feet & 10ths	29⁹⁵	23⁹⁵	21 ⁹⁵
	65' Refill Feet/Metric Standard	23⁵⁰	18⁹⁵	17 ⁹⁵
	75' Refill Feet/Feet Standard	27⁹⁵	21⁵⁰	20 ⁵⁰
	75' Refill Diameter/Feet & 10ths	40⁵⁰	31⁹⁵	29 ⁹⁵
	18" Repair End with Loop - Dymax	5⁹⁵	9⁹⁵	4 ⁵⁰
	12" Repair End with Loop - Steel	5⁹⁵	4⁹⁵	4 ⁵⁰
	Pre-bent Horseshoe Nail	95¢	75¢	70¢
	Long Straight Horseshoe Nail	35¢	30¢	25¢

FOLLOW US ON INSTAGRAM AND FACEBOOK



Lumber Crayons



DIXON lumber crayons are industry standards for marking wood indoors or out. They are made from high-quality clays and pigments. Their exclusive process produces the strongest, longest wearing crayon on the market. We carry: Soft Blue, Soft Red, Yellow, and Carbon Black.

List	1²⁰
MADSEN'S	
1-11	1.09
12-143	95¢
144+	75¢

Crayon Holder
\$9⁹⁵ Each



Markal Paintstiks



MARKAL "B" PAINTSTIKS are used in log yards and mills where fade resistant marking is important. Paintstiks make long-lasting weather resistant marks on rough, smooth, wet, or dry surfaces. White is priced below.

We also stock: Red, Blue, and some Fluorescent colors. These are slightly more expensive. Call for prices.	List	1⁰⁹
	MADSEN'S	
	1-11	1⁷⁹
	12-143	1⁶⁵
	144+	1⁵⁵

HIGHBALL Tree & Log Paint

HIGHBALL AEROSOL marking paint is fast, convenient, and easy to use. It makes highly-visible marks that are resis-tant to weathering. Shipping is free on orders of 50+ cases or large-quantity bulk-purchases. Call for more information on shipping and delivery. Call for quotes on quantity purchases.



Type	List Price	MADSEN'S	
		1-11ea	12+ea
Tree and log paint			
13 oz aerosol	9⁹⁹	7⁴⁹	6 ⁹⁹
Colors are: Orange, Red, Blue, Green, White, Yellow, Black			
Hi-viz fluorescent paint			
13 oz aerosol	9⁹⁹	8⁴⁹	7 ⁹⁹
Colors are: Red/Orange, Blue, Green			

We can now send this UPS! Call today.



Roll Flagging

This flagging is the brightest and toughest we can find. It has extra plasticizers for increased-flexibility and cold-weathering. It also has a high-tensile strength. The glo colors have extra-coloring for longer-life. It is made in the USA and meets or exceeds GSA requirements.

Color/Type	Size	Roll Length	List	MADSEN'S PRICE		
				1-11ea	12+ea	144+ea
Standard Flagging Colors:						
Orange Glo, Pink Glo, Blue Glo, Lime Glo	1 3/16"	50 yards	2⁵⁸	2⁴⁹	2 ¹⁹	2 ⁰⁹
Red, White, Blue, Yellow, Green	1 3/16"	100 yards	2⁵⁵	2⁴⁹	2 ¹⁹	2 ⁰⁹
Red/White Stripe, Blue/White Stripe	1 3/16"	100 yards	3⁹⁹	3⁴⁹	2 ⁸⁹	2 ⁴⁹
Printed Boundary & Hazard Flagging Type & Color:						
Danger-Stop-Danger (Orange Glo)	1 1/2"	50 yards	4⁸⁹	4³⁹	3 ⁶⁹	3 ³⁹
Timber Harvest Boundary (Pink Glo)						
Property Line (Pink Glo)						
Streamside Management Zone (Orange Glo)						

Custom flagging printed with your company name or special message is available. Call for information about minimum order size, set-up charges, and lead time.

Hand Pruning Saw

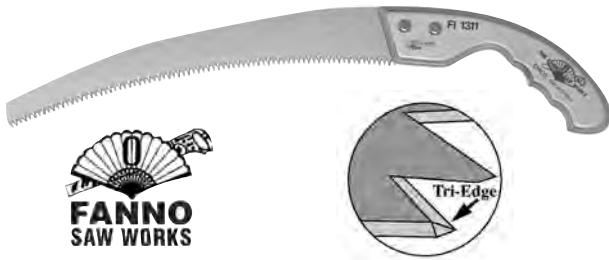

FANNO PRUNING SAWS feature high-quality tri-edge blades. These blades cut clean and fast saving you time and labor. The blades are manufactured in Japan to Fanno's specifications, then imported into the USA, where marine-grade laminated hardwood handles are installed. The result is a high quality, yet affordable hand saw.

Item	List	1-9 ea	10+ ea
Complete Saw	35⁹⁵	29⁹⁵	27 ⁹⁵
Blade Only	22⁹⁵	19⁹⁵	18 ⁹⁵

Hand Pruners & Shears



Leather Scabbard #41428

HAND PRUNERS have rounded handles and an ergonomic grip. Both the #40012 and #40017 are made of high-carbon Japanese steel. The #H308 Thinning Shears have 3" carbide blades.

Tool	List	MADSEN'S
#H308 Shear	14 ⁰⁰	12⁰⁰
#40012 Pruner	18⁰⁰	13⁰⁰
#40017 Pruner	12 ⁰⁰	9⁰⁰
#41428 Scabbard	14 ⁰⁰	12⁰⁰

Throwline Sling Shot



The Big Shot Line Launcher can shoot your throw weight up to a hundred feet into a tree. Kit includes two sturdy fiberglass poles and sling head.

List ~~199⁰⁰~~
MADSEN'S
179⁰⁰

Item #249-541

Throwline Kit

THROWLINE kit includes storage bag, throw weight, and 150' line. These lines are strong and easy to spot in the tree.

List ~~42⁰⁰~~
MADSEN'S
42⁰⁰



Item #THR112K

Rope & Gear Bags



Bags		MADSEN'S
#BAG102	Fits 150' 1/2" Rope	45⁰⁰
#BAG103	Fits 225' 1/2" Rope	59⁰⁰
#BAG113	Throwline Cube	28⁰⁰



High Back Tree Saddle



Saddle Back View



Saddle Front View

The CLIMB RIGHT SADDLE provides superior comfort and support. The back support is 7" high and constructed of fabric belting material. The seat is constructed of 3" wide cotton-webbing that is reinforced with 1 3/4" nylon.

Waist Sizing:			
#SAD304-S	Small	30 - 34	
#SAD304-M	Medium	34 - 40	
#SAD304-L	Large	40 - 44	
#SAD304-XL	XLarge	44 - 48	

MADSEN'S
259⁰⁰

Deluxe Leg Pads

We carry several types of DELUXE LEG PADS, which help make climbing more comfortable. For occasional climbing, standard leg pads are usually adequate, but if you climb often, the leg pads below offer improved comfort.



Super-Climber Pads



Cushion Wrap Pads with Velcro Closure



Cast Aluminum Backed Pad with Rubber Cushion

ALUMINUM PADS have a lightweight cast aluminum body and are lined with dense rubber foam cushioning. Replacement cushions are available.

CUSHION WRAP PADS have a metal insert for keeping the shank stationary to reduce chafing. A Velcro wrap closure keeps the pad in place and offers adjust-ability for maximum comfort.

SUPER-CLIMBER PADS are the widest pads without a steel insert. Two straps on each pad also increases support.

Items	MADSEN'S
#249-741 Cast Aluminum Pads	105⁰⁰
#249-761 Replacement Foam Cushion for Cast Pad	22⁰⁰
#SPU709 Cushion Wrap Pads	229⁰⁰
#85012 Super-Climber Pads	53⁰⁰



Aluminum Climbers & Accessories

ALUMINUM CLIMBERS are lighter than steel and feature a straight shank and offset-stirrup. Unlike one-piece climbers, these utilize a molded aluminum "J" portion that is tailor-matched to an aerospace-quality upright. These are tempered to T-6 hardness and assembled with stainless-steel fasteners.



#91225 Spur Set with
Lightweight Aluminum Pads

349⁰⁰



#91228 Spur Set
with SuperPads

339⁰⁰



#85011 Leather T Pads Only

47⁰⁰



#90070 Lightweight
Aluminum Pads Only

135⁰⁰



#91222 Aluminum
Climbers Only

259⁰⁰

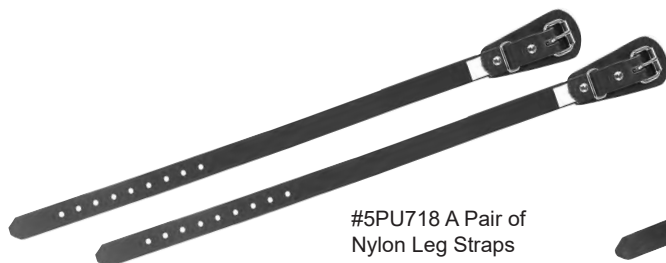

#5PU718 A Pair of
Nylon Leg Straps

28⁰⁰

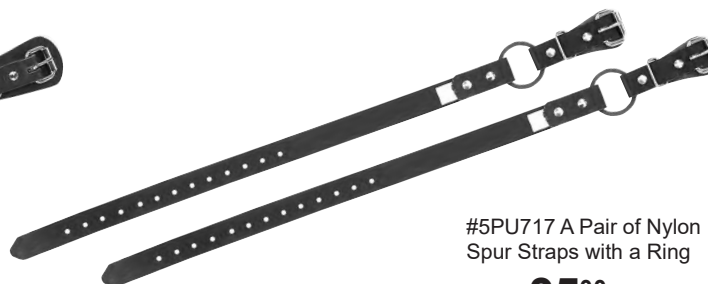

#5PU717 A Pair of Nylon
Spur Straps with a Ring

35⁰⁰



Climbing Rope



1/2" SAMSON ARBOR-PLEX was one of the first lines ever designed specifically for tree-work and remains the choice of many arborists. It is one of the lightest lines we sell, yet has a breaking-strength of 6000 lbs.



1/2" SAMSON TRUE BLUE is a premium rope made of 100% polyester. It is a 12-strand single braid, which helps give it is strong 7300 lbs. breaking-strength.

Rope	120'	150'	200'	600'
Arbor Plex	#AP1212	#AP1215	#AP1220	#AP1260
	85⁰⁰	109⁰⁰	150⁰⁰	440⁰⁰
True Blue	#TB12	#TB15	#TB20	#TB60
	125⁰⁰	165⁰⁰	212⁰⁰	635⁰⁰



Rigging Rope



SAMSON STABLE BRAID is a great rigging line. Its 2-in-1 double-braid construction is a rope within a rope, giving it strength and improving the way it works in pulleys and other rigging hardware. 200' lengths in stock. Comes with eye.

Item	Size	Length	Rating	MADSEN'S
#249-351	5/8"	200' length	breaking strength 16,300 lbs	345⁰⁰
#249-361	3/4"	200' length	breaking strength 20,400 lbs	395⁰⁰

Rope Pulleys



#85225



#85226



#85229



#85230

Item		MADSEN'S
#85225	1/2" Fixed Pulley - 20KN Rating	18⁰⁰
#85226	1/2" Swing Pulley - 20KN Rating	16⁰⁰
#85229	5/8" Swing Pulley - 28KN Rating	22⁰⁰
#85230	3/4" Double Swing Pulley - 35KN	30⁰⁰



Zigzag Mechanical Prusik Plus

MADSEN'S
370⁰⁰

ZIGZAG MECHANICAL PRUSIK allows the user to move around efficiently in a tree using classic Prusik technique. The friction chain provides precision and fluidity when moving around. The pulley is mounted on sealed ball bearings for easy slack-tending. The fixed lower-attachment-hole ensures alignment of the device with the axis of the worker and optimizes grip.

Steel-Core Flip-Line

The STEEL-CORE FLIP-LINE is made of bright orange 5/8" or 1/2" polyester rope braided over 1/4" steel-wire cable. This makes the flip-line strong and cut-resistant. A locking swivel snap is included.

The flip-line is available with or without the rope-grab flip-line adjuster and twisted-clevis.

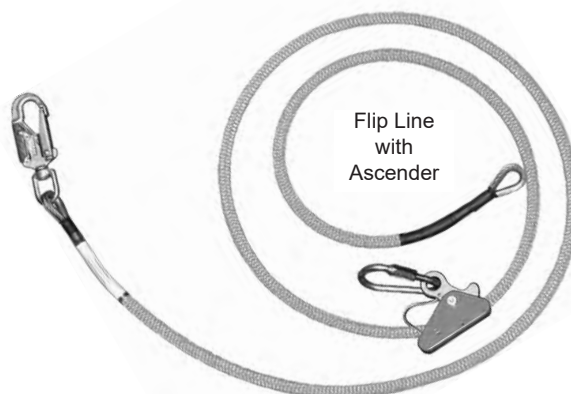

Flip Line Item	MADSEN'S
#75002 1/2" X 10' Line Swivel Only	69⁰⁰
#75011 1/2" X 12' Line Swivel Only	72⁰⁰
#75015 1/2" X 15' Line & Swivel Only	76⁰⁰
#75017 1/2" X 18' Line & Swivel Only	83⁰⁰
#75001 5/8" X 10' Line Swivel Only	80⁰⁰
#75005 5/8" X 12' Line Swivel Only	85⁰⁰
#75016 5/8" X 15' Line & Swivel Only	90⁰⁰
#75018 5/8" X 18' Line & Swivel Only	99⁰⁰

Flip Line Item	MADSEN'S
#75223 1/2" X 12' Line with Adjuster	148⁰⁰
#75224 1/2" X 15' Line with Adjuster	150⁰⁰
#75225 1/2" X 18' Line with Adjuster	155⁰⁰
#75242 5/8" X 10' Line with Adjuster	152⁰⁰
#75243 5/8" X 12' Line with Adjuster	155⁰⁰
#75244 5/8" X 15' Line with Adjuster	159⁰⁰
#75245 5/8" X 18' Line with Adjuster	169⁰⁰

Yale Maxi Steel-Core Flip-Line

MAXI FLIP-LINE is made of 3/4" Dacron rope over a steel-core. It is available with or without a Petzl rope-grab adjuster and carabiner.



Flip Line Item	MADSEN'S
#FLI124K 5/8" X 12' Line with Adjuster	248⁰⁰
#FLI125K 5/8" X 15' Line with Adjuster	275⁰⁰
#FLI126K 5/8" X 18' Line with Adjuster	278⁰⁰
#FLI119K 3/4" X 15' Line with Adjuster	260⁰⁰
#FLI120K 3/4" X 18' Line with Adjuster	279⁰⁰

Flip Line Item	MADSEN'S
#FLI124 5/8" X 12' Line Swivel Only	145⁰⁰
#FLI125 5/8" X 15' Line & Swivel Only	155⁰⁰
#FLI126 5/8" X 18' Line & Swivel Only	165⁰⁰
#FLI120 3/4" X 18' Line & Swivel Only	180⁰⁰

Flip-Line Adjuster



US Standard Adjuster

Gibbs Adjuster

FLIP-LINE ADJUSTERS feature a cam-locking mechanism that easily adjusts a flip-line to any length. Unlike a prusik knot, they require only one hand to adjust.

Flip Line Adjuster		MADSEN'S
#85528	US Std for 1/2" - 5/8" rope	62⁰⁰
#85568	Mini US Std for 1/2" rope	58⁰⁰
#ASC104	Gibbs for 5/8" - 3/4" rope	80⁰⁰

Locking Rope Clip

ROPE CLIPS are a handy alternative to carabiners for attaching your climbing line. Both have squeeze lock gates and meet ANSI standards for life support.



Steel Rope Clip
#CAR402

Breaks at: 5000 lbs
Size: 5 1/2" X 2 1/4"
Gate Opening: 3/4"
Weight: 10 oz

18⁰⁰



Aluminum Rope Clip
#CAR410

Breaks at: 6000 lbs
Size: 2 3/4" Wide
Gate Opening: 1"
Weight: 6 oz

23⁰⁰



Steel Swivel Clip
#85330

Breaks at: 5000 lbs
Size: 5 1/2" X 2 3/4"
Gate Opening: 3/4"
Weight: 10 oz

32⁰⁰

Figure 8



FIGURE 8 can be used to control the descent of loads. A good item for a rescue kit.

32⁰⁰

Positive Locking Carabiners

A POSITIVE LOCKING CARABINER requires three motions to open their gate:

1) Push up the sleeve, 2) Twist the sleeve, and 3) Pull the gate inward.



Petzl D
#CAR159TL

Breaks at: 6300 lbs
Size: 4 1/2" X 2 1/2"
Gate Opening: 3/4"
Weight: 2.6 oz

27⁰⁰



Petzl William
#CAR161TL

Breaks at: 5625 lbs
Size: 4 3/4" X 3 1/4"
Gate Opening: 1"
Weight: 3.1 oz

27⁰⁰



Petzl Am'D
#CAR159BL

Breaks at: 6300 lbs
Size: 4 1/4" X 2 1/2"
Gate Opening: 3/4"
Weight: 2.6 oz

27⁰⁰



Petzl Am William
#CAR161BL

Breaks at: 6300 lbs
Size: 4 1/4" X 2 1/2"
Gate Opening: 3/4"
Weight: 2.6 oz

27⁰⁰

Tree Climber's Books

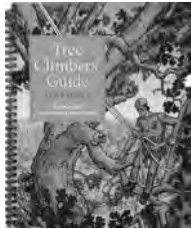

TREE CLIMBER'S BOOKS cover climbing techniques, equipment selection, and much more. Ask about Spanish versions.



Books

MADSEN'S

- #B00101 Tree Climber's Companion **20⁰⁰**
 #B00102 Tree Climber's Guide - 4th **129⁰⁰**

Chainsaw Lanyard

50" CHAIN-SAW BUNGEE LANYARD breaks away at 250 lbs shock load to help prevent the climber from being pulled out of the tree by a falling load hitting the saw. Not for saws over 15 lbs.



Item #249-451

MADSEN'S
40⁰⁰

48" NON-BREAKAWAY BUNGEE CHAINSAW STRAP is blaze-orange.



Item #STR108

MADSEN'S
25⁰⁰

Lowering Device

The PORT-A-WRAP III DESCENDER is a tool for lowering heavy branches or tree sections. It acts as a friction device enabling a single person to control loads many times their own weight. By wrapping the rigging line around the Port-A-Wrap, friction is applied to the rope - the more wraps taken, the more friction applied. This simple tool has a capacity of up to 2000 lbs. The rope shown is for illustration purposes and is not included.

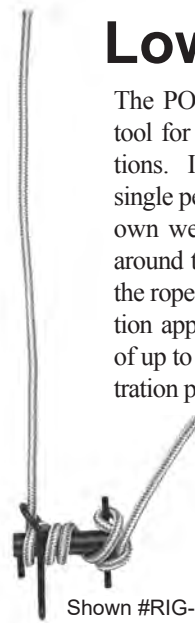

Shown #RIG-113

Item **MADSEN'S**

- #RIG-111 Std **269⁰⁰**
 #RIG-110 Sml **229⁰⁰**

Climbing Helmet



This CLIMBING HELMET features a polycarbonate shell. Chin straps keep the helmet in place when working at any angle.



MADSEN'S
120⁰⁰

Foot Plates

FOOT PLATES attach to your spurs and spread weight beyond your arch for more comfort.



Item #SPU903

MADSEN'S
189⁰⁰

Safety Items



Insect Repellent

INSECT REPELLENT repels mosquitoes, chiggers, ticks, deer flies, stable flies, gnats, and fleas on exposed skin. Protection lasts up to ten hours. 2 oz pump-spray bottle. Item #340-61606.

List ~~9⁷⁹~~
MADSEN'S
 1-11 **6⁴⁹**
 12+ **5⁸⁹**

This is powerful stuff - it contains 98% DEET!

Faller's Whistle

The WHISTLE is brightly-colored and comes with its own neck-string. It gives you "sound communication" in high-noise areas. Item #490-88.



List ~~3⁹⁵~~
MADSEN'S
 1-11 **2⁹⁵**
 12+ **2⁴⁵**

Blood Stopper Bandage

A BLOOD STOPPER BANDAGE is an important safety item for chain-saw operators. This absorbent bandage helps control bleeding from a chain-saw cut. It also helps keep a cut clean during transport. Item #340-525.



It comes sealed in a plastic container and has long fabric ties for firm attachment to an injured area.

List Price ~~5⁷⁵~~
MADSEN'S **4³⁵**
 Pouch for Two #340-777 **7⁹⁵**

Bee Bopper II

BEE BOPPER II quickly kills wasps, hornets, yellow jackets, and bees. The spray will reach a nest mass 10" in diameter when fired from a distance of 20'. Item #340-61011.



List ~~9⁷⁹~~
MADSEN'S
 1-11 **6⁹⁹**
 12+ **6³⁹**

MAX1 Ear-Plugs

MAX1 EAR-PLUGS are meant to be used once. Their soft foam construction provides superior noise blocking performance when compared to other disposables. They are also easy to insert in your ears, yet they resist backing out. They are ANSI rated. Item: 330-MAX1.



List ~~29¢~~
MADSEN'S
 Each **25¢**
 Box (200) **32⁰⁰**

QDI Ear-Plugs

QDI EAR-PLUGS provide protection, and comfort. They are made from foam that requires no rolling prior to insertion. Their built-in stem and contoured shape, makes them easy to insert, remove, and reuse. They are ANSI tested. Item: 330-QDI.



List ~~80¢~~
MADSEN'S
 Each **60¢**
 Box (100) **45⁰⁰**

UltraFit Ear-Plugs

ULTRAFIT EAR-PLUGS provide optimum-protection and superior-comfort. These ear-plugs feature a triple-flange design with "swept back" flanges that are ultra-thin and flexible. They come corded and are available with or without a storage case.



List	2⁹⁵
MADSEN'S	
1-11	2²⁵
12-99	1 ⁹⁵
100+	1 ⁸⁵

Add 50¢ for plugs with case.

Headband Ear-Plugs

HEADBAND EAR-PLUGS enter your ear canal to protect. They will fit most small to large-sized heads. They also come with a spare set of replacement ear plugs. NRR rating 27.



Item #330-222265065

List	11⁵⁵
MADSEN'S	
1-5	9⁹⁵
6+	8 ⁹⁵

EAR Plugs

EAR plugs are made of polymer foam and are comfortable and reusable. To use, just roll each up with your thumb and finger, and insert into each ear. They expand in your ear canals and block out noise.



Item #330-1001

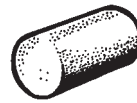

Classic Style - Cylindrical Shape

List	50¢
MADSEN'S	

1-11	30¢
12-199	25¢
200+	19¢

We also carry EAR's FX style shown below. They are made of soft foam and rated at 33 dB.

Item #330-1261



Soft FX Style



MADSEN'S
Box of 200
\$34⁰⁰
That's only
17¢ a pair!



First-Aid Kits

PRO STAT first-aid kits come in sturdy metal containers. Each component is boxed, wrapped, and marked for easy use and replacement. The contents of kits are listed in the left-hand column below. The 24 unit kit meets federal OSHA 1910.266 requirements for small logging or cutting work sites. For larger sites, your state safety organization or employer may require more kits and additional items. Consult the agency with authority for your job site for specific requirements.

Items in a 24 Unit Kit:

- 1 First Aid Booklet
- 1 Triangular Bandage - 40" x 40" x 56"
- 10 Burn Gel
- 1 Instant Cold Pack - 5" x 6"
- 4 Eye Pads with Tape
- 10 Insect Sting Relief Pads
- 20 Antiseptic Wipes
- 4 Gauze Pads - 3" x 3"
- 10 Ammonia Inhalant Pads
- 10 Triple Antibiotic Pads
- 6 Woven Bandage Patches - 2" x 3"
- 2 Adhesive Tape - 1/2" x 2yd
- 1 CPR Mask
- 1 Eye Wash 1 oz.
- 1 Scissors & Forceps
- 2 Gauze Bandage - 2" x 6 yd
- 10 Hand Sanitizer
- 2 ABD Combination Pads - 5" x 9"
- 32 Adhesive Bandage Strips - 1" x 3"
- 1 Burn Stop Dressing - 4" x 4"
- 2 Vinyl Exam Gloves
- 8 Woven Knuckle Bandage
- 8 Woven Fingertip Bandage



MADSEN'S PRICE

- 10 Unit Kit **46⁹⁵**
- 24 Unit Kit **94⁹⁵**

Items in a 10 Unit Kit:

- 1 First Aid Booklet
- 1 Triangular Bandage - 40" x 40" x 56"
- 10 Burn Gel
- 1 Instant Cold Pack - 5" x 6"
- 4 Eye Pad Strips
- 10 Antiseptic Wipes
- 2 Gauze Pads - 3" x 3"
- 10 Triple Antibiotic Pads
- 1 Adhesive Tape - 1/2" x 2yd
- 1 CPR Mask
- 1 Eye Wash 1 oz.
- 1 Scissors w/ Wire Handle
- 1 Clean Wrap 2"
- 10 Hand Sanitizer
- 2 ABD Combination Pads - 5" x 9"
- 16 Adhesive Bandage Strips - 1" x 3"
- 1 Burn Dressing - 4" x 4"
- 4 Nitrile Exam Gloves



No-Fog Lens Cleaner

NO-FOG LENS CLEANER is simple to use. Just squirt it on your lenses, then wipe them clean with a soft cloth. It works on all types of glasses. Users also report that this helps reduce fogging when used on windows in logging equipment that lacks a heater/defroster. Item #330-91167.

- List **4⁹⁵**
- MADSEN'S**
- 1-11 **3⁹⁵**
- 12+ **3⁵⁰**

Safety-Glasses with Magnifying Inserts

These SAFETY-GLASSES have magnification built into the lower portion of the lens -- look ahead and the lens is clear. Magnification available: +1.0, +1.5, +2.0, +2.5, or +3.0. We also carry these with dark sun-glass style lenses: +1.5, +2.0, or +2.5. Item #CH1.



List ~~11~~⁹⁵
MADSEN'S

1-9 **9**⁹⁵

10+ **8**⁹⁵

Not sure what to get? Most people prefer the lower magnifications.



Genesis Safety-Glasses

GENESIS safety-glasses feature a wrap-around lens design that offers great peripheral vision and protection. Meets military ballistic impact requirements. Available with clear or espresso colored lenses. Both the clear and espresso lens is treated with an anti-fog coating.



Clear Lens
#330-3200
Espresso Lens
#330-3241

List ~~15~~⁹⁵
MADSEN'S

1-9 **10**⁹⁵

10+ **9**⁹⁵

With Mirror
Lens Add \$2

Radian Mesh Glasses/Goggles

RADIAN mesh goggles feature fog-free eye protection. They are good for wearing in rainy conditions or in warm working conditions where perspiration fogs conventional safety glasses. They are available as glasses with black temples or with an elastic strap in a goggle style.



Temples
#330-19218
Strapped
#330-19220

List ~~8~~⁶⁵
MADSEN'S

1-9 **12**³⁵

10+ **11**⁷⁵

Nemesis Safety-Glasses

NEMESIS safety-glasses feature a large lens design that wraps-around your eyes for exceptional protection and visibility. The glasses also feature 99.9% UV light protection and an anti-fog coating. Available with: Clear, Smoke, or Blue lenses.



Clear Lens
#330-235
Blue Lens
#330-19639
Smoke Lens
#330-22475

List ~~12~~⁹⁵
MADSEN'S
1-11 **9⁹⁵**
12+ **8⁹⁵**

Bug-Eye Safety-Goggles

BUG-EYE goggles are comfortable, durable and fog-free. No amount of rain or perspiration causes the screen to fog up. The bug-eye design also offers good side visibility. They have an adjustable elastic back-strap.



Item #330-
MAR625172

List ~~25~~⁰⁰
MADSEN'S
1-11 **19⁹⁵**
12+ **16⁵⁰**

Hell Raiser Safety-Glasses

HELL RAISER safety-glasses offer both protection and sunglass-like styling. PPE doesn't have to be clunky and ugly. These good-looking glasses are light-weight, compact, and have scratch-resistant lenses. They are available in clear, amber, blue, or smoke colored lenses. In fact, with UVA lenses, these safety-glasses might become your favorite all-around sun glasses.



Clear Lens
#330-28615
Amber Lens
#330-20541
Smoke Lens
#330-25714

List ~~15~~⁹⁵
MADSEN'S
1-11 **9⁹⁵**
12+ **8⁹⁵**
Add \$3 for UVA
protection

Sight Shield Mesh Goggles

SIGHT SHIELD goggles have tough polycarbonate frames and adjustable back straps. They also have stainless steel wire-mesh lenses for fog-free protection. We carry them in two different mesh sizes: 20 and 30. The 30 is the finest mesh. The 20 is brighter and less likely to hold water-drops. Please specify when ordering.



SIGHT SHIELD

20 Mesh
#330-SS20
30 Mesh
#330-SS30

List ~~35~~⁹⁵
MADSEN'S
1-5 **34⁹⁵**
6+ **32⁹⁵**

Chain Saw Safety-Cap



The CHAIN-SAW SAFETY-CAP is a safety system. It protects your head, eyes, and ears - all with one device. The cap is made of UV stabilized ABS plastic. The hinged visor supports a mesh face-shield that provides protection from wood chips and other small flying debris. The ear-muffs protect the ears plus they help keep the cap in place. The muffs and face-shield can be flipped-up when not in use. Color: Hi-Vz Orange. Item #330-392.

List ~~79⁹⁵~~
MADSEN'S

1-3 **64⁹⁵**

4+ **60⁹⁵**

Replacement
 Suspension **10⁹⁵**

Replacement
 Ear Muffs **19⁹⁵**

Replacement
 Screen
 with Mount **22⁹⁵**

Aluminum Full-Brimmed Hard-Hat



Replace that old worn and dented aluminum hat with one that has the look, fit, and feel of the classic full-brimmed hard-hat, but meets today's ANSI Z89.1 specs. Like the old hat, it comes with a replaceable four-point suspension, but this one has a twist-adjust feature for quick and easy fit. The main difference between this and the classic hat is a new safety panel riveted inside in the top of the crown. This improves protection with little additional weight. Item #330-SKB.

Natural Silver Hat
59⁹⁵

Pictured left is a natural "silver" hat. Add \$7. for bright orange.

Replacement
 Suspension **14⁹⁵**

Replacement
 Ratchet
 Suspension **23⁹⁵**

Screen Face-Shield



The SCREEN FACE-SHIELD protects your eyes without the discomfort of wearing goggles. It hooks around the edge of most full brimmed hard hats. The screen is mounted on a hinge assembly and will tip-up out-of-your-way when not in use.

List ~~25⁰⁰~~
MADSEN'S

1-11 **27⁹⁵**

12+ **22⁹⁵**

Screen Only **12⁴⁵**

Polyethylene Hat or Cap



The V-GARD CAP has a small visor. The hat is full-brimmed like the popular aluminum hard-hat. Both are made of fluorescent red/orange lightweight polyethylene. This material is non-conductive and won't dent like aluminum hats. The hat is also available in several other colors. Item #330-9360



Caps and hats come with ratchet-suspension. Item #330-8146.

List **29⁹⁵**
MADSEN'S
 1-5 **24⁹⁵**
 6+ **22⁹⁵**

Replacement Standard-Suspension **9⁹⁵**
 Replacement Ratchet-Suspension **14⁹⁵**

List **29⁹⁵**
MADSEN'S
 1-5 **24⁹⁵**
 6+ **22⁹⁵**

MSA Suspension

We still have STAZ-ON SUSPENSION for Mac T hard hats. This suspension has four mounting points and easily snaps in place. Item #330-4231

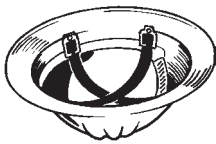

Item #330-4231

List **17⁹⁹**
MADSEN'S
 1-5 **14⁹⁵**
 6+ **13⁹⁵**

Winter Helmet-Liner

The HELMET-LINER is worn under a hard-hat and provides warmth when working in cold-conditions. The portion that covers the neck and ears is knitted. It attaches to the top with a zipper for easy-removal when warm. Item #330-282

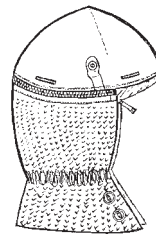

List **23⁷⁵**
MADSEN'S
 1-5 **19⁹⁵**
 6+ **17⁹⁵**

Sweat-Band for Hard-Hat



The HARD-HAT SWEAT-BAND makes wearing a hard-hat on a hot day much more comfortable. The sweat-band is made of soft and absorbent terry-knit fabric, which absorbs sweat. This helps keep sweat out of your eyes when working in warm weather. The sweat-band is universal fit and will snap around most any brand of hard-hat suspension system. Note: The suspension system shown is not included in the price of the sweat-band. Item #330-632.

List **10.95**
MADSEN'S
 1-5 **8⁹⁵**



Labonville Cut-Protective Chaps

OUTSIDECHAPS are worn *outside* your regular work pants. They are held in-place by a waist-belt and leg-straps secured by Fastex® buckles. These are light, strong, and easy-to-release.

Many chain-saw operators favor this type of cut-protection because it can be put-on and taken-off as needed. This is convenient on jobs where saw use is occasional and the wearer doesn't want to wear cut-protection all of the time. It is also good for use at mills or log yards where several users on other shifts share a single garment.

Labonville chaps are made in the USA by a company that has been making cut-protective garment for over thirty years. These Pro Chaps meet the '95 OSHA standards for leg-protection. They have 6-plys of cut-protective fabric, a polyester/Kevlar® knit developed for Labonville (see the picture below). The chap's shell is made from 1000 denier Cordura nylon, which is a tough and stain-resistant fabric.



Overall Length	Part Number	MADSEN'S	
		1-3	4+ ea
Short - 28"	#850KPS	100⁹⁵	98 ⁹⁵
Regular - 32"	#850KPR	110⁹⁵	108 ⁹⁵
Long - 36"	#850KPL	115⁹⁵	112 ⁹⁵
XL - 40"	#850KPX	122⁹⁵	119 ⁹⁵
XXL - 44"	#850KPXX	130⁹⁵	128 ⁹⁵



Shown is a chap we cut during a test. Note the loose fibers that have snagged the saw's chain. Fibers also traveled into the saw's side cover, slowing the drive mechanism.

What size chaps should you buy?

Chaps are not sized like pants, where length is determined by the length of your inseam. Chaps are sized by overall length. *To determine the correct size you need, measure the distance from your belt to your instep.* Chaps that are too short will leave areas of the leg exposed and unprotected. Chaps that are too long can impede movement and cause tripping. When wearing boots with built-in cut-protection, the chaps can be fitted to overlap as shown above. Before buying chaps, also check with your employer and the safety agency with authority on your job-site for details on the safety apparel you need. If you require an item not listed, please call.

When should chaps be replaced?

Chaps should be replaced if they become damaged or matted. Even a small cut shortens the cut-protective material inside, which greatly reduces its protective qualities, so they can't be patched. If your chaps are cut, don't patch 'em - replace 'em. Over time, chaps also get soaked with gas, oil, and sweat. This also reduces their cut-protective qualities. They can be laundered, but this does not completely restore the level of protection they originally offered, so matted chaps should be replaced, too.



Labonville Snap-In Safety-Pads

SNAP-IN SAFETY-PADS are worn on the inside of your pants. They require special pants, fitted with upper-snaps and knee-pockets (see below).

Many timber-fallers prefer this type of leg protection because it allows more freedom of movement than chaps worn on the outside. With outside-chaps, straps and buckles add weight and can get hung-up on brush. Inside-chaps are lighter and require no straps or buckles because they are held in-place by the pants.

What size safety pads do you wear?

- Regular length is for people up to about 6'.
- Tall is for long legged people or over 6'.

Note: Safety pads should extend from the waist to the top of the foot.



Cut-away side-view of a pad in safety-pants. Note the sleeve in the knee area and snaps on top.



Shown is the front-view of a pair of safety-pads. Price includes both pads.

Size	List	MADSEN'S	
		1-3	4+
#SP500KPR Regular Length	95 ⁹⁵	69 ⁹⁵	67 ⁹⁵
#SP500KPL Tall Length	97 ⁹⁵	72 ⁹⁵	69 ⁹⁵

Like outside chaps, SAFETY PADS are not represented as shields against damage, but as an aid to help prevent more severe damage in extreme cases.



See page 29 for insulated winter-pants and cool knit-polyester summer-pants that accept these cut-resistant pads.

Jeans for Snap-In Safety-Pads



Knee-sleeves and snaps have been added to these logger's jeans so they can be used with Labonville snap-in safety-pads. If the pants are cut into, the knee-sleeves help hold the safety-pads in place to protect the legs. The snaps also make it easy-to-remove the pads for laundering or for swapping into another pair of jeans.

MADSEN'S

1-3	44 ⁹⁵
4+	42 ⁹⁵

See the Key Single-Front Jean listing on page 44 for sizes.



Faller's Pants

FALLER'S PANTS accept Labonville snap-in safety-pads for chain-saw cut-protection and come in two types:

- The Winter faller's-pants are made of water-repellent black nylon and insulated with 3M Thinsulate. This makes them perfect for cold and drizzly days.
- The Summer faller's-pants are made of loose knit green polyester. This durable fabric is very cool in hot weather. Suspender buttons are sewn inside the waist of both types of faller's-pants.



Winter
#WN600P

See our safety chap page for prices and information on the LABONVILLE safety chap pad system.

Type **MADSEN'S**

Winter Pants Waist Sizes:

30, 32, 34, 36, 38, & 40 **125⁹⁵**

Size 42 add \$6.

Wool Shirt-Jac

The WOOL SHIRT-JAC is made of red/black plaid fabric. This fabric is made of 65% recycled wool 20% acrylic, and 15% other fibers. A black nylon "yoke" covers the shoulders, chest, and upper-back providing wind and water repellency. The jacket also has a zipper-front, snapping wrist-cuffs, two chest-pockets, and two side slit-pockets. Sizes: M to 5XL. Item #472.



List ~~130⁰⁰~~
MADSEN'S
109⁹⁹

Size 2-5X add
\$10

Insulated Flannel

The INSULATED FLANNEL SHIRT has a half-zip front and two front patch pockets. Its flannel outer is woven in a buffalo plaid pattern and made of 80% cotton and 20% polyester. Inside is a waffle insulated body. The sleeves are lined with polyester satin for easy movement. Colors: Red/Black, Green/Black, or Blue/Black. Sizes: M to 2XL. Item #7221.



HICKORY SHIRT
CO.

List ~~39⁹⁵~~
MADSEN'S
32⁹⁵

Cold Weather Wear



#214MER

**BIG
BILL**

Wool Pants & Jacket

WOOL PANTS & JACKET are made from green 18 oz felted-fabric, which is 80% merino wool and 20% nylon. The pants feature a zipper-front and six inside suspender-buttons. They also have belt-loops. Waist size: 32" - 42". The inseam is 33". The jackets are available in: M-3XL. Both are made in Canada.

Wool Wear	List	MADSEN'S
Wool Pants	120⁰⁰	104⁹⁹
Wool Jacket	157⁰⁰	146⁹⁹



#461MER

carhartt Zip-Front Vest

The ZIP-FRONT VEST is made of 12 oz cotton duck fabric. This fabric is softened with a sand-stone finish. The main seams are triple-stitched for extra durability. For pockets, the vest has two large sherpa-lined front pockets, two inside pockets, and a map pocket on the left chest. The vest also features a drop-tail for extra back coverage.



Style: #104277
Outer Fabric: Cotton Duck
Insulation: Sherpa Lining
Color: Black, Gravel, Carhartt Brown, & Navy
Sizes: S -3X

MSRP 89⁹⁹
Add \$10 for 3X

CALL FOR MADSEN'S DISC. PRICE

carhartt New Detroit Jacket

The NEW DETROIT JACKET has a micro-sanded shell for softness and comfort. The lining in the body is an updated blanket style, while the sleeves are lined with quilted nylon for easy movement. Other features include a pocket on the left chest and two front welt pockets. This is a great coat for both work or casual wear.



Style: #103828
Outer Fabric: Cotton Duck
Insulation: Blanket Body & Quilted Sleeves
Color: Black or Brown
Sizes: S - 5XL

MSRP 119⁹⁹
Add \$10 for Big & Tall sizes.

CALL FOR MADSEN'S DISC. PRICE



Safety Sweat Shirts

SAFETY SWEAT SHIRTS are available with or without hoods. The body is made of orange poly/cotton blend fleece with three high-visibility yellow stripes on the chest and back.



Safety T-Shirt

The SAFETY T-SHIRT features three high-visibility yellow stripes across the chest and back. Each stripe is 2" tall and 12" wide. T-Shirt fabric colors: Orange or Black.

Sweatshirt	List	MADSEN'S	4+
Crew Neck	22⁹⁵	21⁹⁵	19 ⁹⁵
Hooded	31⁹⁵	29⁹⁵	26 ⁹⁵

Call for price of 2X, 3X, & 4X.

This is an inexpensive safety solution for job sites where visibility is important. It's 100% cotton body is comfortable even in warm working conditions.

List	14⁹⁵
MADSEN'S	
M-XL	13⁹⁵
2XL-4XL	17 ⁹⁵

1/4 Zip Safety Sweat Shirt



The 1/4 ZIP SAFETY SWEAT SHIRT is popular with loggers because it is similar to a 1/4 zip hickory shirt. This garment features high-visibility yellow stripes on the chest and back. It also has a handy front pouch pocket.

List	60⁰⁰
MADSEN'S	
	44⁹⁵



Hi-Viz T-Shirts



The HI-VIZ T-SHIRT is made of moisture-wicking mesh fabric. It is available in lime-yellow or orange and has silver reflective stripes. It also has a left chest-pocket. This garment meets ANSI class 2 specs. Sizes: S - 5X.

Sweatshirt	List	MADSEN'S	4+
Short Sleeve	16⁹⁵	13⁹⁵	12 ⁹⁵
Long Sleeve	26⁹⁵	19⁹⁵	18 ⁵⁰

Call for price of 2X, 3X, & 4X.

Hi-Viz Safety Vests



Style #230-SV622

The HI-VIZ SAFETY VEST is made of bright-orange 100% polyester fabric. It also has two-tone reflective stripes sewn on the shoulders and waist. The vest also features a zipper closure and eight handy pockets.

List ~~25~~⁹⁵
MADSEN'S

1-5 **19**⁹⁵
6+ **18**⁹⁵



Style #280-SV2Z

The HI-VIS SAFETY VEST is made of bright-orange polyester and has 2" sewn-on reflective bands. It also features a zipper front closure and a left-chest pocket for convenience. Color: Orange. Sizes: M -5XL.

List ~~9~~⁹⁵
MADSEN'S

1-5 **8**⁹⁵
6+ **7**⁹⁵



Style #280-SV55

If you need pockets, the SURVEYOR'S VEST has them, including a back pouch with zipper closure. The orange vest features sewn-on reflective bands in the front and back. Sizes: M - 4X.

List ~~59~~⁹⁵
MADSEN'S

1-3 **49**⁹⁵ For
4+ **47**⁹⁵ 2X-3X
add \$1.



Sweat Shirts

List ~~\$59.95~~

Madsen's
\$53.95

For 2XL add
\$2

List ~~33~~⁹⁵

MADSEN'S

M-2XL **32**⁹⁵



For 2XL
add \$2.

The Hoodie Sweatshirt features an American Grit image with reflective stripes on its body for high visibility. This is a 3M-HI-VIS with a 95% polyester and 5% spandex body. Sizes S-2XL

The HOODIE SWEATSHIRT features images like the steelhead shown above (Call for other images). It is screened in bright yellow and white, which may satisfy some safety requirements. The fleece body is made of 50% cotton and 50% polyester. Sizes: M-2X.

Short Sleeve T Shirt

The SHORT SLEEVE T SHIRT is made of black 100% polyester birds-eye knit fabric. This fabric is durable, comfortable, and hides stains and soiling. The shirt features contrasting 2" reflective stripes on its body for visibility. It also has a microphone tab on each shoulder to make it easier to use a radio. Item #S396.



List ~~29⁹⁵~~
MADSEN'S
 S-5XL **19⁹⁵**

Short Sleeve Safety T

The SAFETY T SHIRT has a yellow body and black bottom to hide stains and dirt. It is made of durable polyester birds-eye knit fabric which wicks perspiration for work comfort. The shirt features contrasting 2" reflective stripes on its body for visibility and has a class II rating. It also has a microphone tab on each shoulder to make it easier to use a radio. Item #ST11B.



List ~~19⁹⁵~~
MADSEN'S
 S-5XL **14⁹⁵**

Hi-Viz Hoodie

The HI-VIZ HOODIE is made of poly-cotton knit fabric for all-day comfort. It also has a full-zip front, which makes the garment easy to put on and take off. The upper portion of the body is made of bright yellow fabric and has reflective stripes sewn-on for extra visibility. The bottom portion is made of black fabric, which helps hide stains and grit. Item #UB316.



List ~~60⁰⁰~~
MADSEN'S
 S-5XL **49⁹⁵**

Hooded Safety Jacket

The HOODED SAFETY JACKET is waterproof and features a pack-away adjustable hood, an elastic waistband, and adjustable cuffs. The upper portion of the jacket is bright yellow and has reflective stripes sewn-on for extra visibility. It also has lots of handy pockets, including one on the left-chest for a radio. Item #US367.



List ~~90⁰⁰~~
MADSEN'S
 S-5XL **69⁹⁵**

Zip Hoodie Sweat Shirt

The ZIP HOODIE SWEAT SHIRT is made of black fleece and features grey reflective stripes on its body. It is not ANSI rated. Item #F143.



List To ~~59⁹⁵~~
MADSEN'S

M-4XL **49⁹⁵**

Duck Safety Vest

The DUCK SAFETY VEST offers comfort and function. It keeps your body warm, while allowing free movement of your arms. It is made of durable cotton duck fabric and features reflective stripes on its body. It also features a quilted-polyester lining, a rib-knit collar, and hip gussets. Item #SV06.



List To ~~69⁹⁵~~
MADSEN'S

M-4XL **58⁹⁵**

Hi-Viz 2-In-1 Jacket

The HI-VIZ 2-IN-ONE JACKET is a versatile garment for use in a variety of conditions. The waterproof shell protects from the rain, while the combination of bright-yellow and black fabric panels along with reflective tape, offer contrast and extra visibility. It even has a pack-away hood for extra versatility. The removable polyester fleece liner, is good for use in cold working conditions. It can be zipped out when only the shell is needed or worn separately for layering under a different garment. Item #US368.



This is the removable fleece liner that zips out.

PORTWEST®

List To ~~79⁹⁵~~
MADSEN'S

M-5XL **59⁹⁵**

Hi-Viz Jacket

The HI-VIZ BOMBER JACKET is made of bright orange waterproof polyester fabric with a black bottom. It has a removable liner for warmth. The waistband and cuffs are elasticized for a snug fit. Pockets include one for a cell-phone that is concealed under the storm-flap and two additional welt-style pockets that are built into the stomach area. A pack-away hood stores neatly behind the collar. Item #CA160.



PORTWEST®

List To ~~90⁹⁵~~
MADSEN'S

M-4XL **65⁹⁵**



Tuff Black Rain Gear

TUFF BLACK RAIN GEAR is made of heavy-duty 400 denier nylon-fabric coated with polyurethane waterproofing. The heavy-duty nylon is nearly impossible to tear and the polyurethane coating resists abrasion and punctures.

Jackets feature a storm front with plated-brass hardware. The overalls have a storm-fly and heavy-elastic suspenders. Both garments have sealed seams. If you are looking for tough rain gear, this is it!

Piece	List Price	MADSEN'S	
		1-3 ea	4+ ea

Polyurethane on Nylon

Color: Black.

Sizes: S - 2XL, 3X add \$6.

Rain Coat #450SCJ	80⁰⁰	69⁹⁵	64 ⁹⁵
Snap-on Hood #450HODBLK	15⁰⁰	10⁹⁵	8 ⁹⁵
Bibbed Rain Pants #450BTF	80⁰⁰	69⁹⁵	64 ⁹⁵



Breathable Gore-Tex® Rain Gear

GORE-TEX® rain gear outperforms regular rain gear because it holds out rain, while allowing perspiration to escape. With breathable rain gear, you won't finish the day drenched in sweat like you do when working in conventional rain gear. It is also more durable than most Gore-Tex® rain wear sold at sporting goods stores. It is made of industrial Gore-Tex® fabric, which is a heavier duty material. The seams are also stitched and sealed.

Piece	List Price	MADSEN'S	
-------	------------	----------	--

Gore-Tex®

Color: Green

Sizes: M - XL, for XXL add \$20.



Rain Coat #260-900	369⁹²	289⁹⁹	
Bibbed Pants #260-950	369⁹²	289⁹⁹	
Rain Hood #260-975	94²⁹	72⁹⁹	



Rain Gear

Our RAIN GEAR offers the best combination of protection, durability, and comfort... all at a reasonable price. Jackets are full-cut across the chest and back for extra arm-mobility. This is important for comfort when swinging an axe or other upper-body activity. They also feature stand-up collars and storm-fronts for protection from the elements. The full-cut bibbed pants have heavy-duty elastic-suspenders and tough non-corrosive nylon hardware. Seams are stitched and sealed with heat-tape.

If you are BIG or TALL, you've probably had difficulty finding rain wear. We stock sizes up to 5XL in both Neoprene and Polyurethane coated nylon styles. If you need something bigger, up to 7XL is available, and for special needs, we can have rain wear custom made. If you need rain wear, we can help you.

Description	Piece	Price	MADSEN'S
			
<p>NEOPRENE coated nylon is the traditional logger's rain gear we've carried for years. It is cut from a roomy pattern to allow arm and body movement. Better coatings and modern fabric allow it to be lighter and more flexible than the old neoprene gear, but it is still tough and resistant to gas and oil. It is available in green only.</p>			
<p>Neoprene on Nylon Color: Green. Sizes: S - XL, 2X add \$10., 3X add \$25., 4X add \$25.</p>			
	Rain Coat #260-200	136⁰⁰	89⁹⁹
	Bibbed Pants #260-250	136⁰⁰	89⁹⁹
	Rain Hood #260-491	26⁵⁰	19⁹⁹
			
<p>POLYURETHANE coated nylon rain gear is light and flexible, even when cold. It is cut from a roomy pattern similar to the gear above. The combination makes this gear easy-to-move-in and comfortable.</p>			
<p>Polyurethane on Nylon Color: Green Sizes: S - XL, for 2XL add \$6.</p>			
	Rain Coat #260-600GRN	117⁰⁰	84⁹⁹
	Bibbed Pants #260-650GRN	117⁰⁰	84⁹⁹
	Rain Hood #260-675GRN	22⁰⁰	15⁹⁹

"Might as well have the best"
FILSON
SINCE 1897

Tin Wear



FILSON tin wear is popular with loggers and those who do physical work in rainy weather. The wax-treatment “repels” water, yet the canvas fabric breathes to vent perspiration. This helps keep the wearer from becoming drenched in sweat, a common discomfort with conventional “water proof” rain gear. Also, its cotton canvas construction makes it some of our most durable wet-weather-wear.

DOUBLE TIN PANTS have two layers of fabric that extend from the waist to below each knee for extra durability. They feature four deep pockets with storm-flaps on the two rear ones. They are also bar-tacked at all strain points and riveted steel buttons are used on the fly and suspender anchors. These are the classic "tin pants" worn by loggers and timber fallers for decades.

EXTRA WAX FINISH is for restoring the wax on wear/flex areas on tin garments. With time and use, knees, elbows, and other areas benefit from a fresh application of wax. This helps maintain water-repellency in older garments.

Type	List	MADSEN'S
Tin Pants - Double: 30" to 44" Waist	215⁰⁰	Call for Price



Extra tins of wax finish for tin wear are \$5⁰⁰ ea.

“Packer” Hats

The TIN PACKER HAT is made of fabric similar to what is used to make tin pants. It offers excellent protection from all types of weather, and like the tin pants, it is extremely durable. Item #60015-TN.

The SHELTER CLOTH PACKER HAT is cut and shaped from the same pattern as the Tin Packer Hat, but made with shelter cloth, a finer woven oil-finished fabric. Both hats are the same price, so please specify size and type when ordering. Item #60017-OT.



List ~~75⁰⁰~~
MADSEN'S
Call for Price

Filson Hats	S	M	L	XL	XXL
Hat Size	6 ³ / ₄ -6 ⁷ / ₈	7-7 ¹ / ₈	7 ¹ / ₄ -7 ³ / ₈	7 ¹ / ₂ -7 ⁵ / ₈	7 ³ / ₄ -7 ⁷ / ₈
Head Measure	21 ¹ / ₈ -21 ¹ / ₂ "	21 ¹ / ₈ -22 ¹ / ₄ "	22 ⁵ / ₈ -23"	23 ¹ / ₂ -23 ⁷ / ₈ "	24 ¹ / ₄ -25 ⁵ / ₈ "



Oil Finish Wax

OIL FINISH WAX is for restoring the wax on wear/flex areas on FILSON tin garments. With time and use, knees, elbows, and other areas benefit from a fresh application of wax. This helps maintain water repellency in older garments. It can also be applied on other garments like hats and caps for added water repellency. Item #250-20278928. Size 10oz.

MADSEN'S

5⁰⁰

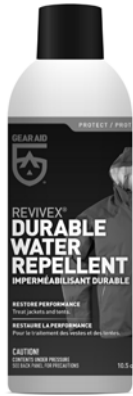

Water Proofing Spray

ReviveX® WATER PROOFING is ideal for rain gear, tents, or boots. If your favorite waterproof jacket or soft-shell has lost its water resistance, or your rain gear is no longer shedding rain, don't throw it out! Spray on ReviveX® Durable Waterproofing to create or restore water, oil and stain repellency on all your favorite outerwear. Size: 16.9 oz. Item #280-36225.

List ~~17⁹⁵~~
MADSEN'S

1-5 **15⁹⁵**
6+ **14⁹⁵**



Fabric Cement

TEAR MENDER is great for fixing work clothes. It permanently binds fabric, canvas, leather, or any material it can penetrate, so it's perfect for patching jeans, pack sacks, tents, and upholstery. It dries in minutes and is waterproof. Customers report patches stay flexible and attached even after garments are washed and dried many times. Bottle size is 6 ounces. Item #280-TG6H.

List ~~13⁹⁵~~
MADSEN'S

12⁹⁵



Tenacious Fabric Tape

TENACIOUS TAPE is a weatherproof fabric-backed tape that is great for fixing torn or cut rain gear. Simply peel and stick, no sewing skills or heat required; simply remove backing and apply. It permanently bonds to outdoor fabrics and materials including nylon, vinyl, rubber, and plastic. It sticks to almost any surface and is tougher than duct tape. Whatever needs a quick fix Tenacious Tape will handle it. Available in Black #280-10689 or Clear #280-10691.

List ~~5⁹⁵~~
MADSEN'S

4⁹⁵



Classic Cotton Handkerchief

This HANDKERCHIEF is large sized and made of cotton. It is available in: Red #4142R, Blue #4142N, or Black #4143B.

List ~~3⁹⁹~~
MADSEN'S

2⁷⁵



Madsen's Caps

MADSEN'S CAPS are made of brushed cotton-twill. All caps also feature a high-stitch-count embroidery on the crown. They come in many colors, which constantly change, but black and camo are always available.

Madsen's caps are high-quality. They are priced below cost as a way of saying "Thanks" for your business -- and for advertising for us. Your recommending us to your friends and family is the best advertising there is. We appreciate it.

MADSEN'S
Twill Cap **7⁹⁵**



Wool Crusher Hat

This is a genuine Effanem wool crusher hat. It is made in the USA of 100% wool. In the days before hard-hats, this was commonly worn by woodsmen in the Northwest. Old logging photos show these on countless logger's and saw men. Even though hard-hats have replaced this as a work hat, it remains a favorite of hunters and outdoorsmen. Wool Crushers are available in: S - XL Colors are: Red, Flame Orange, & Green.

List ~~45⁰⁰~~
MADSEN'S
Each **29⁹⁵**



carhartt Knit Cap

CARHARTT KNIT stocking caps are made of jersey-knit acrylic. While not as warm as wool, they don't have the scratchy feel. The caps will stretch to fit any size head. Color is: Black, Brown, Navy, or Gray. Item #A18.

MSRP
Each **19⁹⁹**

CALL FOR MADSEN'S DISC. PRICE



carhartt Helmet Liner/Mask

CARHARTT HELMET-LINER MASK is made of 92% polyester and 8% spandex. It offers full-face protection that extends below the neckline. The mask portion can easily be pulled down when needed. Item #A267.

MSRP
Each **29⁹⁹**

CALL FOR MADSEN'S DISC. PRICE



Knit Cap with LED Lamp

KNIT CAP WITH LED LAMP features a rechargeable LED lamp built into the acrylic knit body. The lamp can be charged in a USB port and has a run time four hours on a single charge. The lamp produces 150 lumens of brightness. This is a great cap for working on equipment on a typical cold and dark Alaska winter day. The cap is available in orange, yellow, or black knit. Item #330-B029.

List ~~18⁰⁰~~
MADSEN'S
Each **14⁹⁵**



Heavyweight Wool Underwear

HEAVYWEIGHT WOOL UNDERWEAR is standard equipment for winter work in Alaska and the Pacific Northwest. Its rib-knit weave is absorbent and warm, even when wet. It also has flat-locked seams for extra wear. The union-suit design has a trap-door in the seat, a button-front, and snug-fitting cuffs. Made in Canada.

	Size	List	MADSEN'S
#1300 Union Suit	S - XL	175⁰⁰	144⁹⁹
#1300 Union Suit	2XL	205⁰⁰	169⁹⁹

Ask about quantity prices.

Traditional Red Cotton Union-Suit

The RED UNION-SUIT is made of 100% rib-knit cotton. This smooth knit makes it comfortable to wear. It also features a button front-placket and reinforced stitching on all seams. And yes, it still has a vertical seat-flap for... you know. Sizes: S - 2XL Style #865US.



List To ~~34⁹⁹~~
MADSEN'S
27⁹⁵



Wool Blend Underwear

WOOL BLEND THERMAL underwear is a two-layer knit-blend. The outer layer is 70% polyester and 30% merino wool. The inner-layer is 100% Hydropur. This gives you the comfort of Hydropur next to your skin, the warmth of wool, and the wearability of polyester. Sizes of tops or bottoms: S to 3XL Color: Grey. Style #975 DR/LS.

Top or Bottom per piece:
 List Price to ~~28⁹⁹~~
MADSEN'S 20⁹⁹
 Add \$3 for 2XL,3XL & LT





Ice-Tex HydroPur Underwear

ICE-TEX HYDROPUR UNDERWEAR is dual-faced. Against your skin is fleeced HydroPur. HydroPur fiber has the highest rate of absorbency and highest rate of evaporation of any performance fiber on the market. Silver ions imbedded in its fiber during the polymer stage also give the garment a level of odor control. The outside is combed cotton. Tops are Style #286LS. Bottoms are Style #286DR.

HYDROPUR
fiber

Top or Bottom per piece

List Price to ~~21⁹⁹~~

MADSEN'S 16⁹⁹

Add \$2 for 2XL

Work-Dry Underwear

WORK-DRY THERMAL UNDERWEAR is made of 5.5 oz. polypropylene rib-knit, so it is lightweight, but warm. Polypropylene wicks moisture, keeping you warm and dry. This underwear also features rib-cuffs on the top and an elastic-waistband on the bottoms. Tops are Style #21LS. Bottoms are Style #21DR.

Note: Polypropylene underwear is not a good choice to wear while welding. Its fibers will melt if exposed to hot sparks.

Top or Bottom per piece

List Price to ~~21⁹⁹~~

MADSEN'S 16⁹⁹

Add \$2 for 2XL



Max Cold Underwear

MAXIMUM WEIGHT THERMAL UNDERWEAR is made of 9.1 oz. waffle-knit fabric and is rated for extremely cold temperatures. The waffle-knit is a blend of 50% cotton and 50% polyester. This traps a layer of air and body heat air near your skin, insulating you from the cold. Style #822 DR/LS.

This is high-quality, well constructed, underwear. Its top features a rib-knit neck and cuffs. The bottom has an elastic waist-band.

Top or Bottom per piece

List Price to ~~16⁹⁹~~

MADSEN'S 11⁹⁹

Add \$2 for 2XL.



carhartt Double-Front Jeans

DOUBLE-FRONT LOGGER'S JEANS are made of durable 15 oz prewashed cotton denim. They feature a comfortable full-cut, a side-tool-pocket, two full-size back pockets, and triple-stitched seams. They are available with or without suspender buttons. Note: Double-Front jeans offer longer wear in the area around the knees, but the extra layer of fabric does not provide additional chain-saw cut protection.

Double Front Inventory:		
30 x 30	30 x 32	
31 x 30	31 x 32	31 x 34
32 x 30	32 x 32	32 x 34
33 x 30	33 x 32	33 x 34
34 x 30	34 x 32	34 x 34
36 x 30	36 x 32	36 x 34
38 x 30	38 x 32	38 x 34
40 x 30	40 x 32	40 x 34
42 x 30	42 x 32	
44 x 30	44 x 32	

Type	MSRP
#104944 Without suspender buttons	54⁹⁹
#103890 With Suspender Buttons	69⁹⁹

CALL FOR MADSEN'S DISC. PRICE

carhartt Double Duck Dungarees



DOUBLE DUCK DUNGAREES are made from the same cotton duck fabric found in Carhartt coats and overalls. This canvas-like material is tough, yet comfortable to wear. These pants are made more durable by the additional layer of fabric around the knees where work pants are often cut or damaged. Colors: Brown, or Black. Item #106679.

Brown Duck Inventory:		
29 x 30	29 x 32	
30 x 30	30 x 32	
32 x 30	32 x 32	32 x 34
34 x 30	34 x 32	34 x 34
36 x 30	36 x 32	36 x 34
38 x 30	38 x 32	
	40 x 32	
	42 x 32	

#106679 MSRP \$59.99
 #103334 MSRP \$69.99 (RELAXED)

CALL FOR MADSEN'S DISC. PRICE

These don't have suspender buttons. See page 56 for add-on buttons.

Soft Knees for Double-Front Pants



SOFT KNEES slip in-between the layers of fabric on most double-front pants. They are made of high-density foam, which helps cushion knees on hard surfaces. They also help protect from heat or cold. These pads are less cumbersome than strap-on pads and are always there once they are installed in pants. Note: This foam does not provide chain-saw cut protection. Item #280-416.

List ~~20⁰⁰~~
MADSEN'S
17⁹⁹



TOUGH DUCK Double Front est. 1939 **Logger's Jeans**

TOUGH DUCK LOGGER'S JEANS are made of durable 14.75 oz cotton denim and cut from a generous pattern. They feature double-fronts for extra wear and durability. They also have six riveted suspender-buttons, triple-stitched side-seams, and bar-tack reinforcements. Their hardware includes a brass zipper, rivets on stress-points, and a riveted button on the waistband closure. Best of all, these quality work pants are value priced. Item #WP04.

Logger's Jeans Size Inventory:			
30 x 30	30 x 32		
32 x 30	32 x 32	32 x 34	
34 x 30	34 x 32	34 x 34	34 x 36
36 x 30	36 x 32	36 x 34	
40 x 30	40 x 32	40 x 34	
42 x 30	42 x 32		
44 x 30	44 x 32		
46 x 30	46 x 32		

List ~~49⁰⁰~~

MADSEN'S

1-3 **39⁹⁵**

4+ **36⁹⁵**

Add \$3 Waist Size 46".



PRISON BLUES Logger's Jeans

PRISON BLUES LOGGER'S JEANS are actually made by inmates at a penitentiary in Pendleton, Oregon. Their brand slogan is: "Made on the Inside to be Worn on the Outside."

They are cut from a traditional logger's pattern and made of 100% 14.75 oz cotton denim. They feature a zipper-front, button-closure, and suspender buttons.

Note: Single Front Black Jeans are available in waist sizes 30" to 44" and in leg lengths of 30", 32", and 34".

Sizes in Stock:			
30 x 30	30 x 32		
32 x 30	32 x 32	32 x 34	
33 x 30	33 x 32	33 x 34	
34 x 30	34 x 32	34 x 34	34 x 36
35 x 30	35 x 32	35 x 34	
36 x 30	36 x 32	36 x 34	36 x 36
38 x 30	38 x 32	38 x 34	
40 x 30	40 x 32	40 x 34	
42 x 30	42 x 32		
44 x 30	44 x 32		
46 x 30			

Type	MADSEN'S	
	1-3 ea	4+ ea
#1201111 Single Front	47⁹⁹	44 ⁹⁹
#1211111 Double Front	54⁹⁹	51 ⁹⁹
#1201212 SF Black	47⁹⁹	44 ⁹⁹

Big sizes are slightly higher.



Traditional Logger's Jeans

KEY LOGGER'S JEANS are "dungaree" cut to be roomy and easy to work in. In fact, if you remember the old LEE logger's jeans, the cut is almost identical.

They are made of durable 100% cotton denim and have heavy-duty suspender buttons, a zipper-fly, full-sized pockets, and rivets on stress-points.

Sizes in Stock for Single-Front Blue Jean:

	30 x 30	30 x 32		
	32 x 30	32 x 32	32 x 34	
34 x 29	34 x 30	34 x 32	34 x 34	
36 x 29	36 x 30	36 x 32	36 x 34	36 x 36
38 x 29	38 x 30	38 x 32	38 x 34	38 x 36
40 x 29	40 x 30	40 x 32	40 x 34	
42 x 29	42 x 30	42 x 32	34 x 36	
	44 x 30	44 x 32		
	46 x 30	46 x 32		
	48 x 30	48 x 32		
	50 x 30	50 x 32		
	52 x 30	52 x 32		

Type

MADSEN'S

1-3 ea 4+ ea

#446.41 Single Front **29⁹⁵** 25⁹⁵

446 Add \$3 44-48 Add \$5 50-52

#447.41 Double Front **34⁹⁵** 30⁹⁵

447 Add \$4 sizes 44-48

Double-Front Inventory:

30 x 30	30 x 32		
32 x 30	32 x 32	32 x 34	
33 x 30	33 x 32	33 x 34	
34 x 30	34 x 32	34 x 34	34 x 36
36 x 30	36 x 32	36 x 34	36 x 36
38 x 30	38 x 32	38 x 34	38 x 36
40 x 30	40 x 32		
42 x 30	42 x 32		
44 x 30	44 x 32		
46 x 30	46 x 32		
48 x 30	48 x 32		



Prewashed Double-Front Logger's Jeans

PREWASHED DOUBLE-FRONT LOGGER'S JEANS are made of 14.75 oz cotton denim. They feature a brass zipper, button-closure on the waist-band, a hammer-loop, suspender buttons, and a side tool-pocket. Style #48011.45.

These jeans can be worn for casual wear, yet are durable enough for work. Their prewashed finish gives them the look and feel of old favorites right from the start.

List ~~42⁹⁹~~

MADSEN'S

1-3 **34⁹⁵**

4+ **30⁹⁵**

Double Front Inventory:

30 x 30	30 x 32	30 x 34
32 x 30	32 x 32	32 x 34
34 x 30	34 x 32	34 x 34
36 x 30	36 x 32	36 x 34
38 x 30	38 x 32	38 x 34
40 x 30	40 x 32	40 x 34
42 x 30	42 x 32	
44 x 30	44 x 32	
	46 x 32	
	48 x 32	

Add \$4.00 for waist sizes 44-48



Double-Front Denim

The KEY Contractor Grade Double Front Denim Dungaree includes:

- *100% Cotton, 14oz. Denim Fabric, Enzyme Washed
- *Chap Style Double Knees with Cleanout
- *Rivets at Stress Points
- *Double Utility Pockets on Right Leg
- *Single Utility Pocket on Left Leg
- *Reinforced Double Bottom Front Pockets
- *Triple Needle Stitching
- *Relaxed Fit

CALL FOR SIZES

List Price: \$39.99

Madsens Price \$32.95

Style # 403.45



Double Knee Duck Dungaree

The KEY Premium Double Knee Duck Dungaree includes:

- *100% Cotton, 10oz. Duck Fabric, Brushed, Washed Finish
- *Oversized Leg Opening Fits Over Boots
- *Double Utility Pockets on Right Leg
- *Reinforced Oversized Back Pockets
- *Loop for Tape Measure/Cell Phone
- *Hammer Loop
- *Double Knee
- *Relaxed Fit

CALL FOR SIZES

List Price: 34.99

Madsen's Price: \$29.95

Style # 453.07 (Black)

Style # 453.28 (Saddle)

KEY **Denim Bibs**
Est 1908



DENIM BIBS are made of unwashed 12 oz. cotton denim. With the exception of a few minor changes, they are built the same as they were in 1908. Other features include triple-needle stitching, true diamond-back construction, reinforced front and back pockets, button side-closures, adjustable shoulder straps, and a double utility-pocket on the right leg. Style #273.41.

List ~~49⁹⁹~~
MADSEN'S
39⁹⁵

Size 48+
add \$3.

Sizes in Stock:		
32 x 30	32 x 32	32 x 34
34 x 30	34 x 32	34 x 34
36 x 30	36 x 32	36 x 34
38 x 30	38 x 32	38 x 34
40 x 30	40 x 32	40 x 34
42 x 30	42 x 32	42 x 34
44 x 30	44 x 32	
46 x 30	46 x 32	
48 x 30	48 x 32	
50 x 30	50 x 32	
	52 x 32	

KEY **Insulated Bibs**
Est 1908



INSULATED BIBS are made of 12 oz. cotton duck canvas and insulated with bonded polyester fiberfill. They also have a two-way front zipper and brass leg zippers, which zip to the waist for easy on and easy off. The bibs also feature elastic inserts in the suspenders for comfort and double knees for durability. Other features include two exterior chest pockets and two interior storage pockets. Brown only. Style #275.29.

List ~~94⁹⁹~~
MADSEN'S
84⁹⁵

Tall sizes
add \$7.

Sizes in Stock:		
S Short	S Regular	
M Short	M Regular	
L Short	L Regular	L Tall
XL Short	XL Regular	XL Tall
2X Short	2X Regular	2X Tall

KEY **Chambray Shirts**
Est 1908



CHAMBRAY SHIRTS are made of lightweight 4.5 oz fabric. This fabric is 100% cotton, a natural fiber that feels good against your skin. It will also absorb and wick the perspiration that often accompanies hard work, making the shirts comfortable all season wear. Shirts are cut from a "relaxed-fit" pattern making them comfortable to move and work in. The fabric is also prewashed to soften it. When worn for casual wear, its light blue color looks good when the shirt is worn along with a pair of denim jeans. For winter work, the shirt can be part of a layering plan and be worn under a sweat shirt or over long underwear. It is available with long or short sleeves. Sizes: S - 3XL. Style #517.



Shown left is the short-sleeve Chambray

MADSEN'S
#507 Short Sleeve **23⁹⁵**
#517 Long Sleeve **26⁹⁵**
Talls & 3XL add \$2.



carhartt Zip Sweatshirt

The ZIP SWEATSHIRT is made of 13 oz. fleece. This fleece is 80% cotton/20% polyester and treated with Carhartt's Rain Defender water-repellent finish. The sweatshirt features a three-piece hood with draw-cord closure and mock neck-collar with 8-inch brass zipper. It also has a front hand-warmer pocket with a hidden security-pocket inside. Sizes: S - 4XL. Colors: Black, Grey, and Navy. Style #100617.



MSRP

Each **69⁹⁹**

Talls & Bigs add \$5.

CALL FOR MADSEN'S DISC. PRICE



carhartt Hooded Sweatshirt

The HOODED SWEATSHIRT is made of 10.5 oz fleece, which is knitted from a blend of 50% cotton and 50% polyester fiber. The garment features a three-piece hood with draw-cord closure. It also has spandex-reinforced rib-knit cuffs and waist-band. A front hand-warmer pocket is also included. The Carhartt signature logo is printed on the left sleeve. Sizes: S-2XL. Colors: Black, Navy, or Carbon. Style #K288.

MSRP

Each **59⁹⁹**

CALL FOR MADSEN'S DISC. PRICE

Hickory Shirt Co.

A HICKORY SHIRT is a durable and comfortable garment. It is made of 100% striped cotton-twill, which is really a medium-weight cotton denim. Since its made of a natural fiber, it is absorbent, so a hickory shirt stays comfortable even when you sweat. This tough fabric also lasts and lasts.

Hickory shirts are available with either a half-zip or button-style front. A short-sleeve half-zip version is also available. All our hickory shirts are cut from roomy patterns, so you never bind up, even when swinging an axe. They also have large button-down pockets for carrying needed items.



Button Hickory

Long Sleeve Zipper & Button Front Hickory Shirts:
 Regular Sizes: Small, Medium, Large, Extra Large
 Big Sizes: 2XLarge, 3XLarge, 4XLarge, 5XLarge
 Tall Sizes: Med Tall, Large Tall, XLTall, 2XL Tall
 Big & Tall: 3XL Tall, 4XL Tall



Short-Sleeve Half-Zip Hickory

Shown left: We offer a zipper-front hickory with short hem-finished sleeves. This is for warm weather work when you want more than a T-shirt, but a long sleeve hickory is too much.



See page #54 for kid sized hickory shirts.

MADSEN'S

1-3 **24⁹⁵**

4+ **22⁹⁹**

MT to 4XLT add \$3.

Lined Hickory Available

KEY Hickory Shirts

Est 1908

A HICKORY SHIRT is made of striped 100% cotton-twill. This is a tough fabric that is also absorbent, so a hickory shirt is even comfortable on a day filled with hard work and perspiration. Both the button style and zipper style are cut from roomy patterns, so they have plenty of room for free-movement. Like the shirts above, they also have two large button-down pockets. Sizes: S - 3XLT.



Zipper Hickory



Button Hickory

Type	List	MADSEN'S
------	------	-----------------

#573.47 Zipper Front	40⁹⁹	35⁹⁵
----------------------	----------------------------	------------------------

#575.47 Button Front	40⁹⁹	35⁹⁵
----------------------	----------------------------	------------------------

#5703.47 Short Sleeve Half Zip	39.99	33.95
--------------------------------	------------------	--------------

Big & Tall sizes add \$3



carhartt 
Heavy Flannel Shirt

This flannel shirt can be worn for work or casual dress. It looks good with a nice pair of jeans, but is also durable enough to hold up as a work shirt. It is made of 100% cotton flannel and features two chest pockets and a button-front. It comes in a variety of colors. **Seasonal style numbers differ.**

Sizes: M - 2XL
 We also carry Talls up to 2XLT

MSRP

Each **49⁹⁹**

Tall Sizes add \$5.

CALL FOR MADSEN'S DISC. PRICE



Heavy Flannel Shirt

The heavy 9 oz FLANNEL SHIRT has long sleeves and tails. The 80% cotton and 20% poly plaid comes in four types of buffalo plaid: red/black, green/black blue/black, and white/black. This flannel shirt is full-cut for comfort and has a button-front. It comes with two pockets with button-clo-sures. **Hickory Shirt Company. Quarter zip also available.**

Sizes in stock: M - 3XL.
 We also carry Talls up to 3XLT.

List ~~49⁰⁰~~

MADSEN'S

1-3 **21⁹⁵**

Tall Sizes and 2XL to 3XL add \$3



Hickory Safety Shirt

A HICKORY SAFETY SHIRT is similar to a classic hickory shirt but has reflective stripes sewn on its body for extra visibility. Like a classic hickory, it has a zipper front and two large button-down pockets. It is also cut from the same roomy pattern. Sizes: S - 2XL.

List ~~38⁰⁰~~

MADSEN'S

31⁹⁵



Short-Sleeve
Classic T-Shirt

carhartt T-Shirt

A CARHARTT T-SHIRT is good for warm-weather work or casual wear. Many are also worn underneath another shirt for layering in cold conditions. It is made of heavy-duty 6.75 oz cotton rib knit. This durable fabric is comfortable and long-wearing. It also resists shrinkage, giving a Carhartt T-shirt a true-to-size fit.

Other features include: Side seam construction, which minimizes twisting and a left chest pocket where a Carhartt logo is proudly displayed. They come in a wide assortment of colors and Madsen's has a complete inventory. Sizes in stock: S - 5XL including Talls in most sizes.



Long-Sleeve
Classic T-Shirt



Short-Sleeve
Henley T-Shirt



Long-Sleeve
Henley T-Shirt

Colors:

Classic Short-Sleeve T-Shirt colors: Black, Brown, Dark Green, Heather Grey, Navy Blue, Port, Carbon, Burnt Orange, Bright Orange & Bluestone.

Classic Long-Sleeve T Shirt colors: Navy Blue, Black, Heather Grey, & Port.

Henley Short-Sleeve T-Shirt colors: Navy, Hunter Green, Black, Port, and Heather Grey.

Henley Long Sleeve T-Shirt colors: Black, Navy Blue, Heather Grey, and Port.

Type	MSRP
------	------

Classic T- Shirts:

#K87 Short-Sleeve	19⁹⁹
-------------------	------------------------

#K126 Long-Sleeve	24⁹⁹
-------------------	------------------------

Henley T- Shirts:

#K84 Short-Sleeve	24⁹⁹
-------------------	------------------------

#K128 Long-Sleeve	29⁹⁹
-------------------	------------------------

Tall and big sizes are slightly higher.

CALL FOR MADSEN'S DISC. PRICE



Long-Sleeve Pocket T-Shirt



The LONG SLEEVE POCKET T-SHIRT is made with comfort and hard work in mind. It's long sleeves protect your arms from scratches and provide extra warmth when the shirt is worn as an undershirt. The cotton-blend fabric is sturdy, yet soft-to-the-touch, so it is durable enough to be worn as an outer-shirt, yet comfortable when worn for layering. The left chest-pocket allows for essentials to be kept right at your fingertips. They are made of 85% cotton and 15% polyester. Colors: Black, Charcoal, Heather Gray, Graphite, and Navy. Sizes: M to 4XT. Style #860.

List ~~21⁹⁹~~
MADSEN'S

Each **17⁹⁵**

Tall Sizes and
 3XL to 4XL add \$1.



Short-Sleeve Pocket T-Shirts



Pocket T Shirt

POCKET T-SHIRTS are made of heavy 6.75 oz 85% cotton and 15% polyester knit-fabric. They feature a left chest pocket, taped neck and shoulder seams, and hemmed sleeves and bottom. The Henley style shirt also features a three-button placket, giving the shirt a dressier look. Both shirts can be worn alone or used for layering under a work shirt. Colors: Black, Green, Navy, or Grey. Sizes: S to 4XT.

Type	List	MADSEN'S
#822 T-Shirt	14⁹⁹	12⁹⁵

Big & Tall sizes add \$1.

\$2 off per shirt with purchase
 of 4 or more.

Madsen's Logo Wear

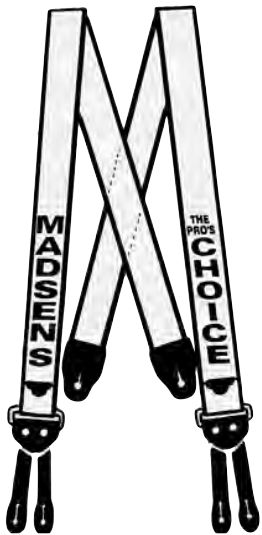

MADSEN'S Suspenders

MADSEN'S suspenders are made of durable 2" wide elastic. This extra-width allows the wearer to support heavier-than-usual work-jeans with pockets filled with faller's wedges or a logger's tape. They are only available with durable leather ends for button attachment to your logger's jeans. Color: Black. Sizes: S - 4XL. Item #LX2.

MADSEN'S
\$33.99



14oz Double Wall
Stainless Steel Vacuum
Mug with Lid \$25.99

MADSEN'S Logo Caps



Limited Supply

Trucker Cap Patch \$29.95
Liquid Logo Grn/Burgdy \$34.95

MADSEN'S T-Shirts



MADSEN'S T-SHIRTS are made of 100% cotton-knit. They are comfortable for both work or casual wear. They are orange with safety-stripes and chain saws.

MADSEN'S

1-3 **19⁹⁵**

4+ **17⁹⁵**

Add \$4. for 2XL-4XL



MADSEN'S Half-Zip Sweatshirt

HALF-ZIP SWEATSHIRTS are full-cut for comfort and look great when worn over a matching T-shirt. You'll want one of these sweatshirts for work, sports, or casual wear.

Madsen's Logo on Sweatshirt:



Type	MADSEN'S
Plain Grey, Blue, or Green: M to XL	21⁹⁵
Plain Grey, Blue, or Green: 2XL	23⁹⁵
Black or Oxford w/logo: M to XL	29⁹⁵
Black or Oxford w/logo: 2XL, 3XL	30⁹⁵

Buy 4+ and save \$2 each.

Women's Boot Socks

WOMEN'S BOOT SOCKS are similar to men's boot socks, but sized for a woman's foot. They are knit from wool blend yarn made of 65% acrylic, 20% merino wool, 13% nylon, and 2% spandex. The ultra-soft merino wool adds warmth and comfort. This heavy-weight sock also features a reinforced arch for added fit and support. It has a flat toe seam for toe comfort and fully-cushioned leg and foot. Made in the USA. They are available in grey. Size: M. Style #2/184.



Huntworth

List ~~14⁰⁰~~

MADSEN'S

2 Pk. **10⁹⁵**

2 Pk. **9⁹⁵**

carhartt Women's Pants



Relaxed Fit Rugged Flex Pants

- Built to move with Rugged Flex stretch technology
- Elastic waistband and drawcord
- Front exposed zipper pockets
- Imported
- 6.8 oz, 55% cotton / 36% polyester / 9% elastane
- Built with Carhartt Force technology to wick sweat and dry fast
- FastDry technology keeps you cool for all day comfort
- UPF 30+ UV protection
- Relaxed fit: Comfortable fit through the seat and thigh with more room to move and a tapered leg opening
- Utility band on wearer's left

Style # 106194
Size: XS-XL

MSRP
69⁹⁹



Relaxed Fit Canvas Pants

- Utility pockets and loop
- Triple-stitched main seams
- 8-ounce, 98% cotton / 2% spandex canvas
- Built to move with Rugged Flex stretch technology
- Relaxed fit: Mid-rise sits just below the waist, slightly fitted through the hip and thigh, and a straight leg opening
- Durable stretch canvas moves, bends and bounces right back
- Flexible waistband for comfort and coverage
- Front pockets constructed to help smooth and flatter

Style # 105113
Sizes: 0-16

MSRP
59⁹⁹



Double-Front Canvas Pants

- Rugged Flex durable stretch technology for ease of movement
- Mid-rise; sits slightly below the waist
- Easy fit through the hip and thigh
- Utility pockets and loop
- Triple-stitched main seams
- Straight leg opening
- 8.5-ounce, 98% cotton/2% spandex canvas

**CALL FOR MADSEN'S
DISC. PRICE**

Style # 105999
Sizes: 0-16

MSRP
69⁹⁹

Toy Saws



MADSEN'S
29⁹⁵



MADSEN'S
49⁹⁹

Your future logger will love a toy saw like dad runs. Both are battery powered and have moving chains. Both also make a "chain-saw" sound that will delight those too young to run a real chain saw. Not for children under 3 years old.

Kid's Flannel Shirts



KID'S FLANNEL SHIRTS are made of 100% cotton and feature a 1/2 zip front. Additional features include two chest pocket and cuffs with button closures. The buffalo-plaid pattern colors are in: Blue/Black, White/Black, Green/Black, Pink/Black, or Red/Black.

Size	List	MADSEN'S
Infant: 6, 12, 18, 24 Month Size	20⁰⁰	17⁹⁵
Toddler: 2T, 3T, 4T	22⁰⁰	19⁹⁵
Child: 4/5, 6/7	22⁰⁰	19⁹⁵
Youth: 8-10, 12-14	22⁰⁰	19⁹⁵

Buy four or more and save \$1 per piece.

Kid's Hickory Shirts



Got a little logger at home? Now he or she can wear a hickory shirt just like Dad or Grandpa. This durable shirt is a miniature version of the classic button-front hickory.

Size	List	MADSEN'S
Infant: 6, 12, 18, 24 Month Size	24⁵⁰	17⁹⁵
Toddler: 2T, 3T, 4T	26⁵⁰	19⁹⁵
Child: 4/5, 6/7	26⁵⁰	19⁹⁵
Youth: 8-10, 12-14	26⁵⁰	19⁹⁵

Buy four or more and save \$1 per piece.

carhartt Kid's Bib Overalls



KID'S BIBS are made of washed brown duck fabric, a softened version of the durable fabric used to make adult work wear. If your child likes to play with toy dump trucks on a big pile of dirt, your little contractor is going to love these.

Size	MSRP
Infant: 6, 12, 18, 24	32⁹⁹
Toddler: 2T, 3T, 4T	32⁹⁹
Youth: 4, 5, 6, 7	39⁹⁹

CALL FOR MADSEN'S DISC. PRICE

Suspenders for Kids

SUSPENDERS for kids are made of red elastic, and feature steel clips that clamp on to the waistband of most pants. The front is imprinted with either "Dad's Helper", "Grandpa's Helper", or "Little Logger". Color: Red. Sizes: 24", 28", or 32"

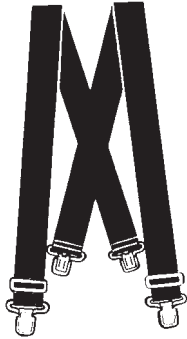

List ~~19⁰⁰~~
MADSEN'S
 1-5 **16⁹⁵**
 6+ **15⁹⁵**

Clip-On Suspenders

CLIP-ON SUSPENDERS are made of heavy-duty black elastic, and feature steel clips that clamp on to the waistband of most pants. The oversize clips are double-plated to withstand moisture and perspiration.



Color: Black only.

Sizes:
 Medium - 46",
 Large - 50",
 X Large - 54"

List ~~23⁰⁰~~
MADSEN'S
 1-5 **22⁹⁵**
 6+ **20⁹⁵**
 Add \$1 for 54"

Sam's
 Tip



To fit suspenders, put on your logger's jeans and hold them at the height you want them. Next, measure the distance from the left front clip-point, across your shoulder, to the right rear clip-point. If your pants have suspender buttons, measure from them.

Leather Covered Felt Shoulder Pad

This SHOULDER PAD threads through one side of your suspenders to protect your shirt when carrying items on your shoulder. The heavy felt pad is covered with durable leather. Item #280-1216.



List ~~14⁹⁵~~
MADSEN'S
 1-5 **12⁹⁵**
 6+ **11⁹⁵**

Leather Belts



LEATHER BELTS are made of durable leather. They are good for work or casual wear. Length: 30"-46" Made by the Amish in the US.

Width	Color	Type	MADSEN'S
1 1/2"	Brown	Plain	29⁹⁵
1 1/2"	Black	Plain	33⁹⁵
1 1/2"	Black	Stitched	43⁹⁵
2"	Black	Plain	43⁹⁵

Suspenders

BACK SUSPENDERS are made of 2" wide cotton elastic and have leather ends for attaching to suspender buttons. They are available in "X" or "Y" back style.

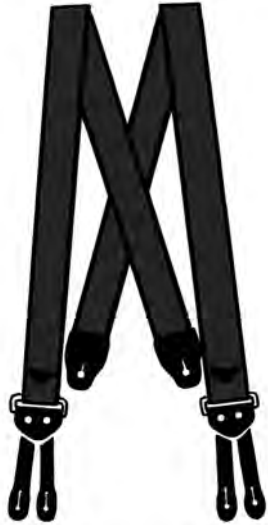

Color: Black only.

Sizes:
Medium - 46",
Large - 50",
X Large - 54"

List ~~23⁰⁰~~
MADSEN'S
1-5 **22⁹⁵**
6+ **20⁹⁵**
Add \$1 for 54".

Buckle Suspenders

BUCKLE SUSPENDERS are made of heavy-duty 2" black elastic and have heavy black leather straps for attaching to suspender buttons. Fitting adjustments are made with buckles instead of welt-clips. They also have metal rings for attaching small items. They are available in "X" or "Y" back style.



Color: Black only.

Sizes:
Small - 42",
Medium - 44",
Large - 46",
X Large - 48",
XXX Large - 52"

List ~~38⁰⁰~~
MADSEN'S
37⁹⁵

Replacement Suspenders Buttons

A package includes eight button sets, which are usually enough to add or replace all the buttons on one pair of jeans and have a couple left over.



MADSEN'S
1-5 **3⁹⁹**
6+ **3⁴⁹**

To install replacement buttons, just stick the pivot through the fabric of your jeans. Set the button over it. Back up the button with a piece of wood and hit the pivot head with a hammer.



Item #280-BB100

Suspender Buttons

SUSPENDER Buttons that are reusable! Simply use an awl or similar tool to pierce a hole from the inside of the jeans. Insert screw and tighten. Package of 6.



List Price ~~\$9.00~~

MADSEN'S
\$8.50

Leather Palm Gloves

LEATHER PALM WORK GLOVES feature a suede cowhide palm and fabric back. They also have a leather knuckle strap and 2 1/2" safety-cuff. These durable gloves are an outstanding value. Sizes: L & XL. Item #290-230.



List ~~6⁹⁵~~
MADSEN'S
 1-11 **4⁹⁵**
 12-35 **4⁷⁵**
 36+ **4⁵⁰**

Suede Drivers

SUEDE DRIVER'S GLOVES are made of brown leather. They feature a pull-strap to cinch the waist of the glove for superior fit. Great for running equipment. Sizes: S to L. 290-150



List ~~10⁰⁰~~
MADSEN'S
 1-11 **5⁹⁵**
 12+ **5⁷⁵**

Wool Faller's Gloves

GREEN WOOL FALLER'S GLOVES are warm and long-wearing. They are knitted from a blend that contains 70% wool. They can be worn alone or as liners for extra warmth. Available in sizes: M, L, & XL.



List ~~7⁰⁰~~
MADSEN'S
 1-11 **4⁵⁰**
 12-35 **4²⁵**
 36+ **4⁰⁰**

Ice Braker Gloves

Double-dipped latex-coated glove
 Looped terry insulation adds warmth
 Textured palm for excellent grip Sizes S-M-L-XL



Item #AG338

MADSEN'S
 1-11 **9⁹⁵**
 12+ **9⁰⁰**

Leather Driver Gloves

LEATHER DRIVER GLOVES are good for all types of equipment operation. They are a slip-on style and feature a shirred elastic back. They are made of cow grain leather for protection and durability. Size: S to XL. 290-100



List ~~11⁹⁵~~
MADSEN'S
 1-11 **9⁹⁵**
 12+ **9⁵⁰**
 Add \$1 for cowhide

Gold Gripper Gloves

GRIPPER GLOVES are similar to faller's gloves, but have a web of flexible rubber that is bonded to the surface of the glove for additional grip. Available in sizes: M, L, & XL. Item #290-19.



List ~~2⁹⁵~~
MADSEN'S
 1-11 **2⁹⁵**
 12-35 **2⁷⁵**
 36+ **2⁵⁰**

White Ox Gloves

WHITE OX GLOVES have four-panel fingers, which improves dexterity, but makes the gloves a little more expensive. Most wearers believe it is worth it. Available with or without elastic back-straps. Size: L & XL in stock. Call for availability and pricing of size M.



List	8 ⁹⁵
MADSEN'S	
1-11	7 ⁷⁵
12-35	7 ⁵⁰
36+	7 ³⁵

Add 50¢ for an elastic back strap and 60¢ for size XL.

Bukaroo Gloves

BUKAROO GLOVES have a leather palm and a canvas back. They are made from a full fit, gunn pattern with a wrap-around index finger and leather finger tips. Item #290-310. Sizes: S to XL.



List	23 ⁹⁵
MADSEN'S	
1-11	21 ⁹⁵
12+	20 ⁹⁵

Add \$7 for insulated version of this glove #290-8310.

Ragg Wool Gloves

RAGG WOOL GLOVES are warm and durable. Their seamless knit-construction is of 85% wool and 15% nylon. The extended cuff length is for added warmth. The gloves are natural oatmeal in color. They are available in sizes: L. Item #290-25T-L,



List	7 ⁹⁰
MADSEN'S	
1-11	4 ⁹⁵
12+	4 ²⁵

Thick Cotton Gloves

THICK COTTON GLOVES are sized for big hands and made of extra-thick cotton on the palm and fingers for cushion and long wear. Item #290-2443.



List	5 ⁹⁵
MADSEN'S	
1-11	3 ⁹⁵
12+	3 ⁵⁰
36+	3 ²⁵

Thermo Grip Gloves

THERMO GRIP GLOVES are knit of 10 gauge acrylic yarn and double-dipped in latex for extra grip and wear. The napped liner helps keep hands warm in cold conditions. Item #WG380. Sizes: S to XL.



List	9 ⁹⁵
MADSEN'S	
1-11	6 ⁹⁵
12+	6 ⁵⁰

Chilly Grip Gloves

CHILLY GRIP GLOVES have a warm synthetic liner and a durable rubber-coated palm. They are flexible and provide excellent grip, wet or dry. They are ideal for construction, fishing, and general labor. Sizes: S to XL. Item# 290-A311.



List	7 ⁹⁵
MADSEN'S	
1-11	6 ²⁵
12+	5 ²⁵
36+	4 ⁸⁵

Atlas Fit Gloves

ATLAS FIT RUBBER PALM GLOVES are made of tight knit cotton with the palm and fingers coated with natural latex. The result is a durable glove with excellent wet grip. The open back provides ventilation. Available in sizes: S, M, L, & XL. Item #290-ATL300.



List	4⁷⁵
MADSEN'S	
1-11	3²⁵
12-35	3⁰⁹
36+	2⁹⁹

Faller's Gloves

WHITE POLYESTER FALLER'S GLOVES are our traditional faller's gloves. They have a snug fit that gives you the ability to pick up items that would be difficult with cotton gloves. Sizes: XS, S, M, L, & XL.



List	1⁴⁹
MADSEN'S	
1-11	99¢
12-35	79¢
36+	74¢

Atlas Therma Gloves

ATLAS THERMA RUBBER PALM GLOVES are similar to the gloves listed above, but the body is constructed of poly/cotton thermal woven fabric for extra warmth on cold days. Thermal's are available in sizes: S, M, L, & XL. Item #290-ATL301.



List	5²⁰
MADSEN'S	
1-11	4²⁵
12-35	3⁹⁹
36+	3⁷⁵

Polypropylene Gloves

BLUE POLYPROPYLENE FALLER'S GLOVES are similar to the gloves above, but are made of 100% polypropylene. This fiber wicks away moisture and provides insulation from the cold. These gloves make good glove liners for wearing underneath regular work gloves in cold weather. Available in size: Large.



List	3⁸⁰
MADSEN'S	
1-11	2⁴⁹
12-35	2³⁵
36+	1⁹⁵

Atlas Nitrile Gloves

ATLAS NITRILE PALM GLOVES feature a seamless nylon liner that has been palm dipped in Nitrile rubber. The thin Nylon liner offers great dexterity, yet is durable and long-wearing. The Nitrile rubber coating also wears like iron. The open back provides plenty of ventilation. The glove is machine washable. Available in sizes: S, M, L, & XL. Item #290-TA370B.



List	6⁸⁰
MADSEN'S	
1-11	4⁹⁵
12-35	4⁵⁰
36+	4¹⁵

Nylon Faller's Gloves

WHITE NYLON FALLER'S GLOVES are tight-knit and made of 100% nylon. This durable fiber doesn't absorb water and wears like iron. Its smooth texture also resists debris build-up. Available in sizes: L & XL.



List	2⁸⁰
MADSEN'S	
1-11	1⁹⁵
12-35	1⁰⁵
36+	99¢

Leather Boot Dressing



OBENAUF'S LP is our best selling boot dressing. It was originally developed for the boots of wildland-firefighters, but works good on logger's boots, too. It is made by blending three different natural oils with bee's wax and propolis. This combination resists bacteria and mildew, repels water, and keeps leather soft and flexible. Here's a tip: LP is a paste, so warming it (in a pan of hot water) prior to application makes it easier to apply. After its application, warming the boots (with a hair dryer) helps the LP soak in and penetrate the leather.

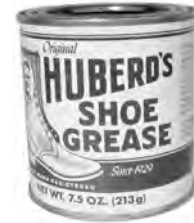

OBENAUF'S leather oil is easy-to-apply and good for touch-ups between applications of LP. It is also good for softening dry leather.



HUBERD'S will darken light-colored leather because it contains pine tar. It is our classic logger's boot grease that we've carried for decades. If your family has a history of working in the woods, your grandfather probably used this product. Huberd's has been making it since 1929.

Description	Size	List Price	1-5 ea	6+ ea
#310-564 Obenauf's LP Boot Paste	8 oz	17⁰⁰	14⁹⁵	13 ⁹⁵
#310-584 Obenauf's Boot Oil	16 oz	20⁰⁰	16⁹⁵	15 ⁹⁵
#310-HSG75 Huberd's Shoe Grease	7.5 oz	16⁰⁰	13⁵⁰	12 ²⁵



Boot Saver Toe Caps

BOOT SAVER toe caps help prevent premature wear of the toe area on a work boot. This is a common problem on boots with hard safety toes. Included in the kit are two caps, sandpaper, and a tube of cement for attaching them. Black only. Item #310-08402.

MADSEN'S

6⁹⁹

Boot Tongue Protectors

TONGUE PROTECTORS (also called false tongues) are cut from leather and fit behind the laces on boots to protect the tongue and gusset leather.

We carry them in two sizes: Long ones fit boots with tall tops and those with a lace-to-toe design. Either can be cut down to fit most any boot. Prices are for a pair.

Type	List	MADSEN'S
#310-SFT Short	7⁹⁹	6⁹⁵
#310-LFT Long	8⁵⁰	7⁹⁵



Boot Laces



NYLON LACES are strong and inexpensive. If you trim them, be sure to heat up the ends. Melting the ends helps keep them from fraying.

LEATHER LACES are a little more expensive than nylon, but are preferred by many loggers. They are more flexible than nylon laces and will not wear out the eyelets in boots as quickly. Our leather laces are uniformly cut from top-quality hide.

KEVLAR LACES are the toughest laces we have. They are not sensitive to heat, so they are a good choice for wild-land firefighters or anyone who welds, or is around sparks. If you want durable laces that will last and last, choose Kevlar.

Size & Type	Fits Boot Top Height	List Price	MADSEN'S	
			1-9	10+
72" Nylon	8"-10"	2⁹⁵	2⁷⁵	2 ²⁵
72" Leather	8"-10"	7⁰⁰	6⁹⁵	6 ⁵⁰
72" Kevlar	8"-10"	10⁵⁰	9⁹⁹	8 ⁹⁹
84" Nylon	8"-10"	3.25	2.85	2.35
84" Leather	8"-10"	7.95	7.50	6.95
96" Nylon	8"-12"	3.25	2⁹⁵	2 ⁷⁵
96" Leather	8"-12"	8.50	7⁹⁵	7 ⁵⁰
108" Kevlar	12"-14"	13⁵⁰	12⁹⁹	11 ⁹⁹
120" Leather	12"-14"	10⁵⁰	9⁹⁵	9 ⁵⁰
120" Nylon	14"-16"	4.25	3⁶⁵	3 ²⁵



PEET[®] SHOE DRYER

It is always good to start the day with dry boots, no matter what weather the morning brings. In addition to comfort, a PEET SHOE DRYER will help keep your feet healthy and make your boots last longer. It is endorsed by boot manufacturers including Danner, Buffalo, and White.

Both the standard and Power Cell dryers plug into a standard 110v outlet.

List ~~59⁹⁹~~
MADSEN'S
49⁹⁹

Insoles



Insoles can improve the fit and comfort of some boots. Wool-felt inserts offer thermal insulation and cushion comfort. They can also be used to improve the fit of boots that are a little too big. This is a common problem when fitting rubber boots. Since rubber boots don't stretch, you must often buy them a little big when your foot is a half-size. In this case, you can improve the fit by adding insoles to take up some space. STYLE VOFIN

List ~~9⁵⁰~~
MADSEN'S
8⁹⁹

Aquaseal Repair

AQUASEAL/FREESOLE can be used to repair worn soles, for fixing separations, or for waterproofing boot stitching. Some also use it to coat the toes on boots for extra protection from abrasion and punctures. It adheres to both leather and rubber. Size is 1.5 ounces.



Item #310-10410

List ~~8⁰⁰~~
MADSEN'S
1-5 ~~6⁹⁵~~
6+ ~~6⁵⁰~~

Duct Tape

DUCT TAPE should be in every crew-bus and often saves a day's work. It can temporarily repair nearly anything - from a torn rain-boot to a broken cover on a saw engine. It's tough and sticks to almost anything.



List ~~7⁵⁰~~
MADSEN'S
Each ~~6¹⁹~~

Replacement Calks

Replace dull or worn screw-in calks (spikes) with a new set of sharp ones. Most calked boots have about 25 spikes per boot, so we sell them in bags of fifty:

- Our standard spikes are made of tool-grade steel for maximum wear and durability. This is our best seller for all-around use.
- The "Redwood" length spike, is similar to the standard spike, but has 1/2" long points. Some customers like these when working around trees with deep bark. If you are tempted to get these thinking they will wear longer than standard spikes, know they tend to pack up more with debris and their length puts extra stress on the receptacles in your boots.
- The Cermec spike has a hardened core. These are standard length and fit into regular receptacles. Their hard core extends their life when working in rocky or abrasive conditions.
- Wesco spikes fit only Wesco boots. These sharp and durable spikes have a nut-shaped sub-base that fits a special tool for easy removal and replacement. They will not fit into standard calk receptacles.



		MADSEN'S PRICE	
Type		1-5	6+
#186	Tool Steel Spikes (50)	17⁹⁵	16 ⁹⁵
#7066	Tool Steel (case of 1000)	249⁹⁹	
#218	Redwood Long Spikes (50)	21⁹⁵	20 ⁹⁵
#1082	Cermec Spikes (bag of 50)	26⁹⁵	24 ⁹⁵
#2002	Wesco Spikes (bag of 50)	29⁵⁰	27 ⁵⁰



Yaktrak Boot Scrubber

List ~~30⁰⁰~~
MADSEN'S
 Each **27⁹⁹**

Item #08401

Mount a Boot Scrubber near the entrance to your home or office and keep dirt outdoors where it belongs. The stiff bottom bristles remove debris from even deep treads, while the soft side-brushes won't scratch your boot's uppers.

Calk Wrenches



Maxpro Ratcheting Calk Wrench

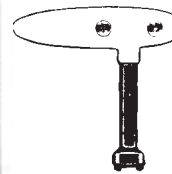

Standard Calk Wrench



Wesco Calk Wrench

		MADSEN'S PRICE	
Type		1-5	6+
#88404	Standard Calk Wrench	5⁹⁵	4 ⁹⁵
#220	Wesco Calk Wrench	10⁰⁰	9 ⁰⁰
#88401	Ratcheting Wrench	9⁹⁵	8 ⁹⁵

 **Calked Boots**



WESCO CALKED BOOTS are available with either 12" or 16" tops. The boot with a 12" top is available in plain toe or semi lace toe, while the 16" version has a plain toe. Both are made of durable black leather with a reversed vamp. This makes the vamp more resistant to damage from the boot's sharp spikes. Additional features include: Rolled leather top facing, an all-leather mid-sole and heel-base, heavy-duty stitching, a formed Stytherm counter, all-leather gussets, removable Ortholite foam slip-in inserts, and removable false-tongues. These boots are rebuildable and are made in Scappoose, Oregon.

12" Top: #1912SI

List ~~611⁰⁰~~
MADSEN'S

549⁹⁹

We stock sizes:
8 - 13 in D & E

16" Top: #2916SI

List ~~646⁰⁰~~
MADSEN'S

589⁹⁹

We stock sizes:
8.5 - 13 in D & E



Georgia Calked Boots

The GEORGIA CALKED BOOT features a waterproof membrane, 200 grams of Thinsulate insulation, a contour insole, and an all-leather upper. Our friends at Hoffman's make this by adding a calked sole to Georgia's comfortable and durable 8" top work boot. Note: Although this boot is made with a waterproof membrane, it is not guaranteed to be waterproof because it has been modified (added calked sole). Style #GEORGIA.

MADSEN'S

329⁹⁹

We stock sizes:
8-13 M width &
8-12 W width
including 1/2 sizes.



Armor Pro Calks



ARMOR PRO CALKS are one of the toughest boots Hoffman's have ever developed. They are made by adding calked soles to a rugged Italian-made mountaineer-style work-boot. This boot features a "stark" coated outer (similar to truck bed lining), which makes the boot more durable and cut-resistant. This adds a level of waterproofing, and extends the overall life of the boot.

Armor Pro calks are available with either an 6" or 8" top. The 6" tops are lighter, but lack the ankle support and protection offered by the 8" version.

8" Top: #AP8
MADSEN'S
469⁹⁹

We stock sizes:
 7-13 in D &
 8-13 in EE



Pronghorn Calks



DANNER doesn't make boots with calked soles, so the original sole tread is ground off by a local boot-maker and replaced with a second sole containing screw-in spikes. The end result is a light-weight Gortex® lined calked boot. The taller tops offer more ankle support than calked hikers and are better for keeping wood chips out of your boots when you run a saw.

These boots are not as durable as conventional leather calks, but they are light-weight, break in quickly, and less expensive. Users also report they are comfortable right from the start. Because calk soles are not part of the boot's original construction, Danner's warranty does not apply. Style# 41340C.

MADSEN'S
359⁹⁹

We stock sizes:
 7-14 in D &
 8-13 in EE



Calked Rubber Boots

CALKED RUBBER BOOTS by Viking Askim have steel-toes and cut-resistant material laminated into the front of these boots. The spiked-bottom soles feature replaceable screw-in spikes. These soles are built into the boots at the factory, so there is no secondary sole to separate. The uppers are made of high-content natural-rubber and the liners are 100% cotton. If you are looking for a durable rubber boot, this is it. Style# VW-65.

List ~~200⁰⁰~~

MADSEN'S

Pair **184⁹⁹**

Available

in whole

sizes:

6 - 13

Also available in Lug Sole **\$129.99**



LW5 Calked Rubber Boots

LW5 RUBBER BOOTS have 9 layers of laminated material into the front of the boots. This provides some chainsaw protection. It is not certified as a chainsaw certified boot. A mixture of natural rubber makes these boots resistant to oils and chemicals.

MADSEN'S

Pair **189⁹⁹**

Available

in whole

sizes:

7 - 13



XTRATUF Calked Rubber Boots

XTRATUF CALKED RUBBER BOOTS are well known for comfort and durability. They are made of tough neoprene rubber, which is softer, lighter, and more pliable than ordinary rubber. They also have a snug ankle fit and 16" tops - two more features loggers like. Since Xtratuf doesn't offer a calked version of this boot, our friends at Hoffman's grind off the regular tread and replace it with an extra sole that contains the replaceable screw-in spikes. Available in whole sizes: 7 - 13.



See page #75 for information on the non-calked version of this boot.

MADSEN'S

239⁹⁹

For an insulated version of this boot add \$10.



10" Grizzly Calk Boots



The Grizzly Calk is one of the latest additions to the line. The Grizzly features a 10" leather upper with a Kevlar PU finish on the leather which helps protect the upper from abrasion. The Grizzly features a waterproof membrane to help keep you dry in wet weather. A protective rubber rand protects the leather upper from sharp edges and debris. The midsole is composed of different densities EVA layers with PU shock absorbing characteristics and stabilizer insert to provide added comfort. Shown with replacement calk sole but also available with a Vibram style sole if needed.

List ~~510⁰⁰~~
MADSEN'S
499⁹⁹

Available
 in whole
 sizes:
 9-12



Calked Rubber Boots



CALKED RUBBER BOOTS by Hoffman have 12" tops and steel-shanks. They feature a full-lace front, which gives them a little more ankle support than most slip-on boots we offer. The lace front also makes the boots easier to put-on and take-off. They also feature a 3mm felt lining for warmth and comfort. Style# 12RIC

List ~~179⁹⁹~~
MADSEN'S
174⁹⁹

Available
 in whole
 sizes:
 6 - 13



Danner **Pronghorn Boots**

PRONGHORN BOOTS are built on Danner's DEP1-H last, which gives these boots more of an athletic fit with a tighter heel-pocket and wider toe-box. They are great for outdoorsmen looking for a boot that is fast and agile. The uppers are made of a combination of durable nubuck leather and 1000 denier nylon. They also have a waterproof and breathable Gore-Tex lining. The outsole is Danner's dirt and rock gripping Talon. These shoes are imported, but their quality is 100% Danner. Style# 41340.

MSRP

269⁹⁵

We stock sizes:
8-15 D &
8-13 EE
including 1/2 sizes

**CALL FOR
MADSEN'S DISC. PRICE**



Danner **Quarry Boots**

QUARRY BOOTS are good for work, hunting, or any outdoor activity. In fact, they are one of the most popular Danner boots we sell. They have black leather uppers and an 8" top. We carry them in two versions: one with a regular toe and one with a non-metallic safety-toe. All have waterproof Gore-Tex liners and dual-density Vibram Cascade soles. Made in USA. Style# 17309.

MSRP

309⁹⁵

We stock sizes:
8-13 D &
8-13 EE
including 1/2 sizes

For boots with safety toe add \$10. Style# 17311



Danner **Logger Boots**

LOGGER BOOTS have a full-grain leather upper with 8" tops. Inside the boots is a 100% waterproof/breathable lining. The boot features include a Vibram 360° out-sole for substantial edging and superior traction. The lightweight Bi-Fit board increases rigidity in the heel and allows for flexibility in the forefoot. Style# 15431.

MSRP

259⁹⁵

We stock sizes:
8-12 D & 8.5-11.5 EE
including 1/2 sizes

**CALL FOR MADSEN'S
DISCOUNTED PRICE**



**Scout / Fire-Fighter's
Boots**

WHITE'S SCOUT / FIRE-FIGHTER'S BOOTS feature full-grain leather uppers with 10" tops. Their Vibram® outsoles provide plenty of grip in muddy working conditions. These boots are NFPA approved for fire fighting. Made in the USA. Men's boots are style #H7809.

MSRP

399⁹⁹

We stock
men's sizes:
7-13 D
8-13 EE

Romeo Slippers



Danner Romeo

DANNER ROMEOS offer the comfort and convenience of a slip on shoe, so at the end of the day, you can remove your boots, and slip on a pair for the ride home.

They feature an extra-plush DCS footbed and plenty of room in the toes for comfort. Wear them a while and you'll discover they are durable, too. They have triple-stitched seams, oiled nubuck leather, and high-traction out-soles. Style #12441.

Madsen's \$155.00



carhartt Romeo

CARHARTT ROMEOS have dark-brown oil-tanned leather uppers with a neoprene stretch-fit ankle. The oil-resistant rubber outsoles are attached using Goodyear welt construction. Their waterproof/breathable lining keeps feet dry, but lets them breathe. Their FastDry lining wicks away sweat and fights odors. Style #FA4015.

Style FM 4000-Plain Toe
Style FM 4200-Steel Toe

List ~~144.99~~
MADSEN'S
129.99

Sizes:
7 - 14 M Add \$5
7-15 W for steel toe



Chinook Romeo

CHINOOK ROMEOS can be worn indoors as slippers or outdoors as shoes. They feature brown all leather uppers, durable elastic side panels, and non-tracking wedge soles. Available in brown or black.

List ~~80.00~~
MADSEN'S
69.95

We stock sizes:
7 1/2 - 13 in both
Medium & Wide

Muck Chore Boots



MUCK CHORE BOOTS feature flex foam booties that are water proof, lightweight and flexible. They form to the wearer's calf for maximum comfort. Customers report these are the most comfortable "rubber" boots they've ever worn. Among their features are steel shanks for added support and moisture control linings that wicks away perspiration.

Type	Part#	List	MADSEN'S PRICE
Chore Boot	#CHH000A	135.00	115.99
Chore w/hard-toe	#CHS000A	145.00	125.99

Available in whole sizes only: Mens: 6-13 Womens: 7-14

Muckmaster Boots



MUCKMASTER BOOTS are similar to Muck Chore Boots but feature aggressive high-traction soles for grip and stability. Additional features include high rubber overlays for protection against rocks and brush, thermal foam underlay for additional warmth and additional achilles overlays for extra protection. Contoured foot-beds offer support and all-day comfort.

Muckmaster Boot
Style#MMH500A

List ~~160.00~~
MADSEN'S
132.99

Available in whole sizes only:
Mens: 7-13
Womens: 8-14

Mid-cut Muckmaster

Style#MMM500A

List ~~150.00~~

MADSEN'S
125.99

Excursion Pro Low Slip On



MUCK EXCURSION PRO slip-ons are similar to the regular Muck boots, but are low cut, making them easy to get on and off. One customer describes his Excursions as "waterproof romeo slippers." If you travel in a boat or motor-home, pack these instead of rubber boots because they take less space.

List ~~115.00~~
MADSEN'S
95.99

Style# FRLC-900

Available in men's whole sizes: 7-13

XTRATUF Rubber Boots

XTRATUF BOOTS are made of neoprene rubber that is triple-dipped in a special sealant. This construction makes them resistant to chemicals and oil. It also makes them softer, lighter, and more pliable than ordinary rubber boots. These boots feature built-in cushion insoles with arch support, fabric lining, supportive heel counters, and extra-thick bumpers for toe and heel protection. The chevron slip-resistant soles grip smooth wet surfaces for better traction and stability.



#22272G
Standard
Sz: 7 - 15



#22274G
Insulated
Sz: 6 - 14



Kid's
Xtratufs
\$44.99

#22490
Lady's Salmon
Sister
Sz: 6 - 10



		MADSEN'S	
Type	List	PRICE	
#22272G 15" Legacy Boot	160⁰⁰	129⁹⁹	
#22274G 15" Insulated Legacy Boot	175⁰⁰	145⁹⁹	
#22490 Lady's Salmon Sister Legacy Boot	170⁰⁰	126⁹⁹	
#22172G 12" Legacy Boot	450.00	124.99	
#22271G 15" Steel Toe Legacy Boot	470.00	139.99	

SERVUS
by Honeywell

PVC XT Boot

PVC XTPS are rugged boots that give dependable waterproof protection at an economy price. They are molded boots that seamless and reinforced at critical stress points. They are made in the U.S. We stock them in whole sizes: 3-13. Plain toe Style #75122.



List ~~45⁰⁰~~
MADSEN'S
31⁹⁹

Diabetic Crew Socks

DIABETIC CREW SOCKS have a knit cotton-blend foot and a loose-fitting top. These socks are recommended for people with diabetes, edema, neuropathy or any kind of foot circulation problem. Color:White Available in size 10-13 & 13-15. Color:Gray Available in size 10-13. Made in the USA. These come in a package of three pairs.



List ~~9⁰⁰~~

**MADSEN'S
PRICE**

3-pack **7⁹⁹**



Over-the-Calf Socks



These 17" OVER-THE-CALF BOOT SOCKS feature moisture control, arch-support, a stay-up leg and top, and a reinforced heel and toe. These work great with tall-topped calked boots like Wesco 16" top boots. The sock is made of 75% ultra-spun polyester, 23% nylon, and 2% Spandex. Made in the USA. Size L. Style #9746.

List ~~9⁰⁰~~
MADSEN'S

1-5 pr **5⁵⁰**
6+ pr **4⁹⁵**

Tall Boot Socks



TALL HEAVY-WEIGHT BOOT SOCKS feature superior a stay-up leg and top, and a reinforced heel and toe. These heavy-weight socks are made of 30% acrylic, 30% ultra-spun polyester, 20% wool, 17% nylon, and 3% Spandex. Made in USA. Size L. Style #822/2. Sold in two-pair packs.

List ~~13⁰⁰~~
MADSEN'S

2-pack **10⁹⁵**
3+ 2-pk **9⁹⁵**



Cold Weather Merino Wool Socks

COLD WEATHER MERINO WOOL SOCKS are extra-heavy-weight for cold-weather working conditions. They feature extra arch support for added fit and have a reinforced heel and toe area. The foot-portion is made of 90% ultra-soft Merino wool and 10% nylon. The leg-portion is made of 45% Acrylic, 40% Merino wool, 13% nylon, and 2% spandex. Made in the USA. Size L. Style #844.

Steel Toe Boot Socks

STEEL TOE BOOT SOCKS have a double-cushioned sole and toe-box, which makes them especially good for use in boots with safety-toes. They are made of 81% acrylic, 18% stretch nylon, and 1% Spandex. This combination of fibers keeps feet dry, warm, and comfortable. They also feature a stay-up leg, a reinforced foot bottom, and a smooth-looped toe-seam. Their precise boot-to-sock fit insures comfort in any type of work boots. Made in the USA. Available in sizes M - XL. Style #6510.

Thermal Boot Socks

RUGGED THERMAL BOOT SOCKS are made of 62% hi-bulk acrylic, 20% stretch nylon, 17% worsted wool, and 1% Spandex. They feature therma-lined construction that absorbs shocks and insulates feet. They also have a non-terry vamp to reduce bulk and a flat toe-seam. The toe and heel – high wear areas – are nylon-reinforced. Made in the USA. Available in sizes M & L. Style #7586.

Merino Wool Socks

MERINO WOOL SOCKS have an outer layer of 85% Merino wool, 14% stretch nylon, and 1% Spandex. The inner-layer is therma-lined for extra-comfort and shock-absorption. The heel and toe are reinforced for extended wear. The toe has a flat smooth seam for extra toe comfort. Super-soft Merino wool provides itch-free comfort and naturally moves moisture away from the foot. The sock also has a Lycra® arch brace for support and snug fit. Available in sizes M, L, & XL. Made in the USA. Style #7014.



Huntworth

List ~~13⁰⁰~~
MADSEN'S
 1-5 pr **11⁹⁹**
 6+ pr 10⁹⁹



FOX RIVER

List ~~17⁰⁰~~
MADSEN'S
 2 pair **12⁹⁵**



FOX RIVER

List ~~14⁰⁰~~
MADSEN'S
 1-5 pr **12⁹⁵**
 6+ pr 11⁹⁵



FOX RIVER

List ~~20⁰⁰~~
MADSEN'S
 1-5 pr **16⁹⁵**
 6+ pr 15⁹⁵

Logger's Socks

Dry feet are comfortable and healthy feet. That's one of the reasons **LOGGER'S SOCKS** are our best-selling work socks. They contain high-bulk Orlon acrylic, a miracle-fiber that wicks moisture away from the feet. When this Orlon is combined with high-stretch nylon, the results are durable socks which will keep your feet warm and dry. The full terry-knit also provides cushion and thermal insulation. Logger's Socks are white with red tops. They are made of 80% Orlon acrylic, 10% cotton, 9% nylon, and 1% Spandex. Available in sizes M - XL. Made in the USA. Style #7587.



FOX RIVER

List ~~14⁰⁰~~

MADSEN'S

1-5 pr **11⁹⁹**

6+ pr 10⁹⁹

Worsted Wool Socks

WORSTED WOOL WORK SOCKS are extra-heavyweight work socks made of 84% worsted wool. This premium wool is preshrunk to insure fit throughout the leg and foot. The balance is a blend of 9% acrylic, 6% nylon, and 1% Spandex. These socks are terry-knit in the foot area, while the leg is rib-knit. The over-the-calf leg length insures a good fit, even with tall rubber or leather boots. Available in sizes M - XL. Made in the USA. Style #7267.



FOX RIVER

List ~~21⁰⁰~~

MADSEN'S

1-5 pr **15⁹⁹**

6+ pr 14⁹⁹

Steel-Toe Wool Socks

STEEL-TOE WOOL SOCKS are made of 88% worsted wool, 10% nylon, 1% high bulk acrylic, and 1% Spandex. They feature a full-knit body with extra-cushion in the toe and sole. They also have flat toe-seams and the heels are reinforced. The added Lycra helps the socks stay up. These are excellent cold-weather boot socks. They will keep your feet warm even in cold working conditions. They are available in sizes M, L, & XL. Made in the USA. Style #6650.



FOX RIVER

List ~~17⁰⁰~~

MADSEN'S

1-5 pr **14⁹⁵**

6+ pr 13⁹⁵

Crew Socks Value Pack

CREW SOCKS VALUE PACK come in a six-pair pack. They are made of 85% cotton and 15% nylon. This mid-weight sock is for light work or everyday wear in moderate to hot temperatures. It can also be used for layering. The cotton fiber absorbs moisture and draws it away from the skin. For most users, this sock works well in shoes and boots with tops 8" and less. Made in the USA. Fits shoe size 6-12. Color: White. Style #6090



List ~~18⁰⁰~~

MADSEN'S

6 Pair **12⁹⁹**



Thermal Work Socks

THERMAL BOOT SOCKS feature a high-impact foot-bed with cushioning that improves performance and comfort. It also wicks moisture away and helps keeps feet dry all day. Available in sizes 10-13 only. Style #JS-STL-100.



JOB SITE

List ~~8⁵⁰~~
MADSEN'S
 Each **7⁹⁵**

Crew Socks Assortment

CREW SOCKS are knitted from polyester/cotton blend yarn with 3% Spandex. This provides a comfortable tight fit. Available in sizes 10-13 only. Style #JS501-4. The price is for a four-pair-pack, of assorted colors.



JOB SITE

List ~~8⁵⁰~~
MADSEN'S
 4 Pair **7⁵⁰**



Ten Pack Crew Socks

CREW SOCKS are knit from polyester/cotton blend yarn with Spandex. They feature a reinforced foot-area that cushions the foot. They are made for work and built to last. Available in sizes 10-13 only. Available in black or white. Style #JS435/10. The price is for a ten-pair-pack, so this is a terrific value.



JOB SITE

List ~~12⁰⁰~~
MADSEN'S
 10 Pair **10⁹⁵**

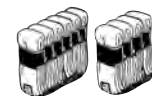

Wool Blend Boot Socks

WOOL BLEND BOOT SOCKS are made of 38% polyester, 31% acrylic, 19% Merino wool, and 9% nylon. This combination of fibers wick moisture from feet and dry quickly. It also offers itch-free comfort not found in all wool blend socks. These socks also feature a reinforced heel and toe area for great durability. Available in sizes 10-13 only. Style #JS600-4. The price is for a four-pair-pack, so this is an excellent value.



JOB SITE

List ~~24⁰⁰~~
MADSEN'S
 4 Pair **16⁹⁹**



Utility Packs

UTILITY packs are made of green cotton canvas. They are available in several styles and types.



Mussette Pack
Item #490-2270



Large Pack
Item #490-2304

Mussette Pack
Item #490-2270

Bags	Size	MADSEN'S
#490-2270 Mussette Pack	11" X 12" X 4"	36⁹⁹
#490-2304 Large Pack	21" X 17" X 8"	49⁹⁹

carhartt Packs & Tool Bags



Tool Bag
Color: Brown
Style #B0000517



Single Back Pack
Color: Brown or Black
Style #B0000553



Single Compartment Pack
Color: Brown or Black Style
#B0000533

The BAG & PACKS shown are made of rugged canvas and have a water repellent finish.

Bags	Size	MADSEN'S
#490-B0000517 Tool Bag	13" X 11" X 7.25"	74⁹⁵
#490-B0000553 Classic Backpack	12" X 18" X 9.5"	44⁹⁹
#490-B0000533 Backpack	12" X 18" X 11"	49⁹⁵

Timber Falling Sign

A TIMBER FALLING SIGN is required on many jobs for road safety. This one is made of high-visibility orange mesh and rolls up for easy storage and transport. Size is: 3' x 3'. An optional three-legged stand also folds for easy transport.



#350-5994 Sign Only **59⁹⁵**
 #359-T55 Tripod Only **53⁹⁵**

Blanket Canteen



MADSEN'S

17⁹⁹

The CANTEEN holds two quarts. It has a blanket cover and is plastic lined.

Warning Signs



WARNING SIGNS are made of inexpensive orange corrugated plastic signboard. They feature common warnings needed by woods workers. Print is large black letters. Size is: 2' x 2'.

List **20⁰⁰**
MADSEN'S
 1-9 **19⁹⁵**
 10+ **18⁰⁰**

Gas Jugs



Madsen's carries several types and sizes of gas jugs. They are made of durable and non-corrosive plastic. Spouts are included. Call us for more information.

Type	Gas Capacity	PRICE
Gas Only Jug	1 gal.	11⁹⁹
Gas Only Jug	2 gal.	14⁹⁹
Gas Only Jug	5 gal.	18⁹⁹

Not Shown: We have a limited supply of steel two-in-one gas/oil jugs. These are similar to the old "Domar" style combo jugs we used to carry, but are made of steel. Price is: \$59.95

Max-Flow Foam Air Filter Systems

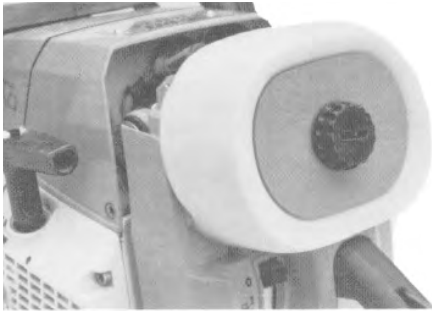

A Max Flow filter system without the rain-cover.

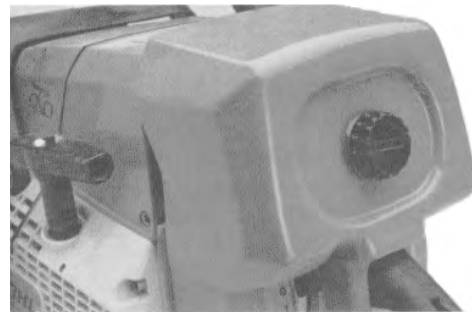

A Max Flow filter system with the rain-cover.

A MAX-FLOW air filter system lets your saw breathe. It is easy-to-install and does not require any modification to the chain-saw engine. The kit includes: A filter cage, a heavy-duty rain-cover, two foam elements, a nut-plate, and instructions. The system can be used with or without the rain-cover.

The foam elements that comes in the kit have different pore sizes for different working conditions: The small-pore foam is for working in dry or dusty conditions. The large-pore foam offers maximum air-flow, but does not filter fine particles as well. Both filters are washable and reusable. MAX-FLOW recommends using BEL RAY foam filter oil after each cleaning.

MADSEN'S PRICE

Kit for STIHL 044, MS 440, 046, MS 460	79⁹⁵
Kit for STIHL MS 461	79⁹⁵
Kit for STIHL MS 500	89⁹⁵
Kit for STIHL MS 661	89⁹⁵
Kit for STIHL MS 880	84⁹⁵
Extra White Foam Elements (Fine-Pore)	17⁹⁵
Extra Green Foam Elements (Large-Pore)	17⁹⁵
BEL RAY Filter Oil - one liter	16⁵⁰

FOLLOW US ON
INSTAGRAM &
FACEBOOK



LOCTITE®



LOCTITE is a pro-saw's friend. It will reduce down time by holding screws, bearings, and other components in place. We use both types in our shop.

LOCTITE #242 THREAD LOCKER:

- Helps hold screws which attach shrouds
- Is good for holding delicate screws
- Is best if you plan to disassemble at a later date

LOCTITE #271 STUD & BEARING MOUNT :

- Helps hold main bearings to case mounts
- Helps hold bar studs & dawg bolts in place
- Should be used when installing TIME-SERTS

Tip: When disassembling a component that was assembled with #271, heat the fasteners to release the bond.

Price is for either #242 or #271. Please specify which type you want when ordering.

List ~~13⁷⁵~~
MADSEN'S
 11.75

Faller's Dawgs

FALLER'S DAWGS are cut from heat-treated alloy-steel. They are designed to be used in matching pairs. Their large tooth-design works great for gripping deep bark. The point positions are also designed to maximize leverage on saws fitted with long guide bars.



Pictured left: This dawg is the outside dawg for a HUSQVARNA 395. It fits outside of the bar cover and is mounted on the bar studs like the factory dawgs. The inboard dawg mounts on the main case on the factory mounting points.

We carry fallers dawgs for current models of STIHL and HUSQVARNA falling saws. Most dawgs are around \$59.95. a set Please specify what model saw you are fitting when ordering.

TIME-SERT® Thread Repair Kit

We repair stripped threads in our shop with TIME-SERTs. We prefer them because they are a solid-bushing thread insert with thin walls and synchronized internal-external threads. When installed correctly, they make an excellent thread repair in an aluminum-alloy case. They are also easy to install and lock into place. Each kit contains a drill, counter-bore, cutting tap, & insert driver. When ordering a kit, please also order inserts.

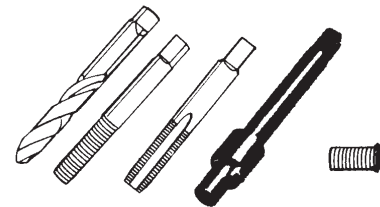

Size X Thread Pitch	For Saws	For Component Repair	Part Number	MADSEN'S PRICE	
				Kit Price	Inserts
4mm X .8	STIHL	oil pump & ignition screws	1407	129⁹⁵	1 ⁶⁵ ea
5mm X .8	STIHL HUSKY	most buffers & housing screws most housing screws	1508	129⁶⁵	1 ⁶⁵ ea
6mm X 1	STIHL	buffer mounts, cylinder bolts	1610	129³⁵	1 ⁶⁵ ea
8mm X 1.25	STIHL	bar studs on most models	1812	149⁹⁵	1 ⁶⁵ ea
10mm X 1	STIHL	spark plug (The new small plug)	4010	249⁹⁵	5 ⁹⁵ ea
14th X 1.25	STIHL	spark plug (Older traditional size)	4412	279⁹⁵	5 ⁹⁵ ea



TRI-FLOW™ Lubricant

TRI-FLOW is a high-grade oil that contains micronized teflon, a corrosion inhibitor, a moisture displacer, and a special solvent. It penetrates inaccessible areas to clean and lubricate. It even breaks down the crystalline structure of corrosion. Item# 210-20007.

Spencer recommends TRI-FLOW for use in their tapes. Customers report it also works well on guns, in fishing reels, and in other mechanisms that require light oil.

List ~~24⁴⁵~~
MADSEN'S
25⁹⁹

NGK Spark Plug

#BPMR7A SPARK PLUG works in most models of STIHL & HUSKY saws. It is a high-quality resistor type plug with an extended tip. It also has a solid top, that doesn't vibrate loose.

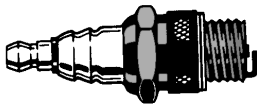

List ~~5⁸⁰~~
MADSEN'S
1-9 **4²⁵**
10+ **3⁶⁰**



Pro Safety Handle Bars

PRO SAFETY HANDLE BARS are made of light-weight and durable aluminum-alloy material. They fit in the factory mounting positions and come with rubber handle grips. Please ask about mounting screws for your application.

Made
In USA

MADSEN'S PRICE
175⁵⁰

Heat Shrink Tubing

HEAT SHRINK TUBING can easily repair damage to the insulation on a saw's wiring. Simply place the tube over the exposed wire, then gently apply heat. The tubing will shrink and grip the wire making a new layer of insulation. This repair is less bulky and more durable than electrical tape. The quantity is one 12" section. Item# HS-12.



List ~~3⁵⁰~~
MADSEN'S
1-9 **2⁷⁵**
10+ **2²⁵**

Black Electrical Tape

BLACK ELECTRICAL TAPE is a timber faller's fix-all. In addition to electrical repair, it can be used to make all sorts of temporary fixes. Having a roll in your tool kit may allow you to tape up a broken handlebar or do some other repair so you to finish a day's work. Item# 210-2001.



List ~~3²⁵~~
MADSEN'S
1-9 **1⁰⁹**
10+ **99¢**

Starter Rope

STARTER ROPE is made of nylon and features a multi-carrier outer-braid and special-core for strength. This unique design resists fraying and wear on starter bushings. The rope is super-strong, yet flexible. It is good for other uses, too.

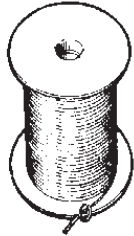

MADSEN'S PRICE

200' roll of 3.5mm (#4.5) **28⁶⁵**

164' roll of 4.5mm (#5.5) **23⁸⁵**

A 3.5' section in either size is \$2.50.

TK-7 Octane Booster



TK-7 OCTANE BOOSTER works great in today's high performance chain saws. When pump octane is too low, add this for more octane. Bottle size is 10 ounces.

Not Available

OREGON Sprocket System

The FLOATING RIM SPROCKET SYSTEM is the ultimate drive sprocket. It allows the chain to align perfectly with the groove in the bar through the use of a rim sprocket that "floats" on a splined hub. Plus, if the chain derails, the spline does not destroy the chain's drive link as much as a spur sprocket. The system is easy to install and is available to fit most chain saws.

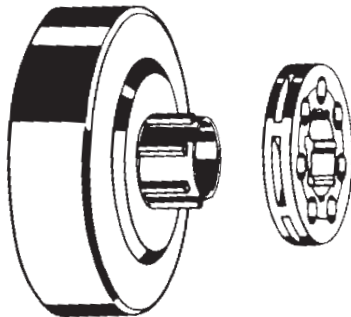

Call us for the price of a system that fits your saw.

Replacement Rims

REPLACEMENT RIM SPROCKETS for the above system are available in 3/8" X 7, 3/8" X 8, and .404" X 7. Please specify pitch and tooth count when purchasing.

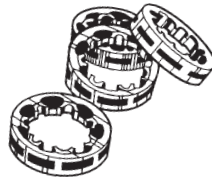

List	10⁹⁵
MADSEN'S	
1-9	8⁹⁵
10+	7⁹⁵

High Tooth-Count Racing Sprocket

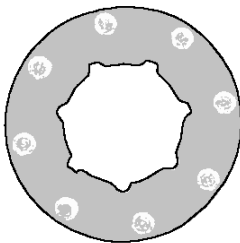

PIN DRIVE RACING SPROCKETS are available in tooth counts from 8 to 16 and in 3/8, .404, and 1/2 pitch. They can be spline-bored to fit OREGON clutch hubs or straight-bored with standard keys. Racing sprockets are made of heat treated alloy steel.

Tip: These do not work well on production saws.

MADSEN'S PRICE

3/8 x 9 pin **65⁰⁰**

3/8 x 10 pin **67⁹⁵**

404 x 8 pin **65⁹⁵**

404 x 9 pin **69⁹⁵**

Carb Adjustment Screwdriver



The CARB ADJUSTMENT SCREWDRIVER has a thin blade and a long shank that fits the adjustment screws on most saw carburetors. It also features a magnetic-end and a handy pocket-clip.

MADSEN'S
1⁹⁵

Digital Engine Tach



Engine RPM is easy to measure with this battery powered DIGITAL TACHOMETER. On saw engines, RPM measurement is accomplished wirelessly by holding the unit near the spark plug wire. There, the unit picks up spark pulses, counts them with its built in micro-computer, and quickly displays the calculation. Carb adjusting becomes simple -- just turn the adjustment screw, watch the tach, and set the desired RPM. #105-110.

MADSEN'S PRICE 71²⁵

Combination Spark Plug & Bar Wrench



COMBINATION BAR WRENCHES fit most European saws. We stock a large inventory of many different styles. Please specify type and version when ordering.

List **4²⁵**
MADSEN'S
1-9 **3⁹⁵**
10+ **3⁴⁵**

Epoxy Repair Kit

QUIK STEEL is an epoxy repair that is good for fixing fuel tanks damaged by thrown chains and so on. The epoxy is resistant to gas, oil, and water. A repair kit contains two tubes -- one is a paste and the other a hardening compound. When mixed together, the blend hardens. Item #210-172.

QuikSteel



List **8⁶⁵**
MADSEN'S
1-5 **6⁵⁰**
6+ **5⁹⁵**

Ratchet Srench



- 13mm & 19mm sockets fit Husqvarna, Stihl and most other chainsaw brands.
- 12-point sockets for precise feel.
- 100% forged steel with chrome-vanadium shaft.
- Socket, switch and rivet are heat-treated and manganese-coated for strength and rust resistance.
- Compatible with most spark plugs.
- Screwdriver tip cleans bar groove.
- Weight: 5.6 ounces

MADSEN'S 22⁹⁹

"T" Handle Torx Wrench



The TORX WRENCH fits most fasteners on late model STIHL saws. #210-432.

List Price **19⁹⁵**
MADSEN'S **16⁹⁵**



Alaskan Saw Mill

How an Alaskan Saw Mill Works

For first level cut nail plank on log. Adjust rollers to remove first slab.

Then use sawn surface as guide to remove bottom slab.

Turn log. Use plank squared up with side. Remove third slab.

Now you are ready to make lumber, beams, fence posts, cross ties, or any timber you need.

Now you can make your own valuable, smooth, and ready to use dimensioned lumber. Mill trees where they fall and produce boards of any thickness -- from half an inch to thirteen inches and any desired length.

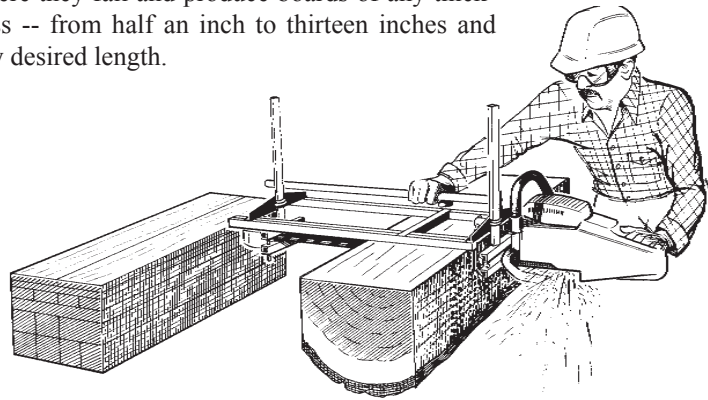

The ALASKAN SAW MILL is a portable mill attachment that clamps to the chainsaw bar. It is best to buy the biggest mill that you think you will ever use because the mill will adjust down to accommodate shorter bar lengths. It is best to power this mill with one or more large chain saw engines.

Size	Description	Maximum Cut	MADSEN'S
24"	Alaskan Mill G-778-24	20"	229⁰⁰
30"	Alaskan Mill G-778-30	26"	269⁰⁰
36"	Alaskan Mill G-778-36	32"	279⁰⁰
48"	Alaskan Mill G-778-48	44"	289⁰⁰
56"	Alaskan Mill G-778-56	52"	309⁰⁰
60"	Alaskan Mill G-778-60	56"	329⁰⁰
72"	Alaskan Mill G-778-72	68"	349⁰⁰

Edging-Mill

The EDGING-MILL is an economical milling device that can be used along with the MK II for squaring logs and edging slabs to increase production. It should be powered with a medium sized power saw. The kit includes 12 feet of guide rail in 2' lengths. Additional rail is available.

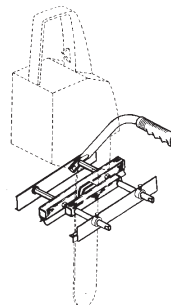

#G-555B
MADSEN'S PRICE
129⁰⁰

Auxiliary Oiler



The OILER ASSEMBLY consists of a tank, mounting bracket, clamps, valves, and tubing. Proper oiling results in greater chain life and increased production.

#G-801

MADSEN'S

59⁰⁰

Helper Handle

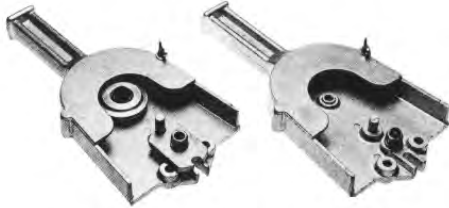

The HELPER HANDLE is available with an idler-roller for use with double-end bars, or without for standard bars. It is made of heavy die cast aluminum for light-weight and extra durability.

With roller #G-975

MADSEN'S

105⁵⁰

Without roller #G-971

MADSEN'S

55⁵⁰

Slabbing-Rail Brackets



SLABBING-RAIL BRACKETS ensure a mill's initial cut is smooth and level. They are used to attach two straight 2X4's to the top of a log. This supports and guides the saw mill. Subsequent cuts do not use slabbing rails, but are guided by the smooth and level surface they helped create.

#G-850

MADSEN'S

42⁵⁰

Milling Winch System



The MILLING WINCH SYSTEM assists the operator by pulling the mill through the cut via a turn on a handle rather than pushing it on the frame.

#G-478

MADSEN'S

119⁵⁰

Long Mill Support Kit



The LONG MILL SUPPORT KIT is an additional cross-support intended for use on mills 48" and wider. Adding one or more of these supports helps stiffen the mill and is especially beneficial to long-spanning rail supports.

#G-778-17

MADSEN'S

44⁵⁰

Chain Saw Winch

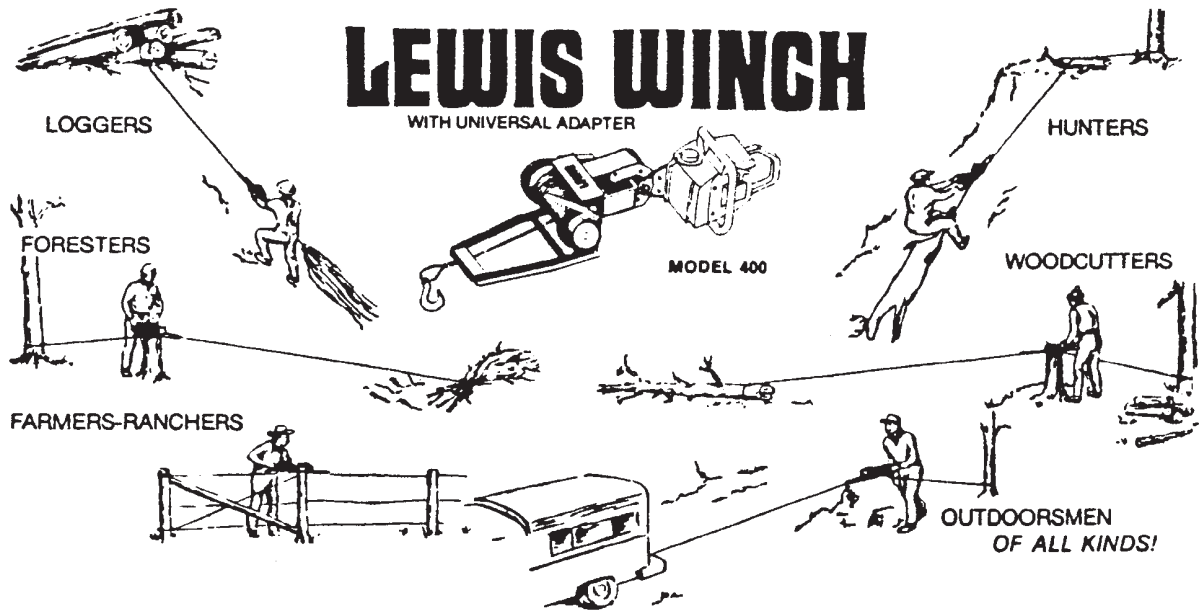

A LEWIS WINCH is great for moving small logs for firewood. Hunters like it for dragging big bucks or for pulling a truck out of the mud that is stuck. The winch has hundreds of uses because it can be taken anywhere you can take a chain saw.

Pulling capacity depends on the size of saw you use for power, but maximum pull is about 4000 lbs. We recommend mating the winch to a mid-sized saw. The engine should be at least 50 cc. This combination will pack a lot of power in a small spot, because like a chain-saw, a Lewis winch is made of lightweight components.



The winch mount shown couples directly to the saw's clutch drum on saws engines with internal clutches. If a saw has an external clutch, the winch is mounted using a small bar and chain which is included.



This saw and winch combination weighs 47 lbs and is 33" long. The power head is a Husqvarna 365 which has a 65cc engine. Also shown is the tri-sided hand knob used to disengage the winch for free-wheeling.

List Price ~~1199⁰⁰~~
MADSEN'S PRICE
1049⁹⁹

A Tree Saver Winch Strap is \$62⁵⁰.
A Snatch Block is \$89⁰⁰.

Assembly, installation on your saw, or spooling of the cable onto the reel is an additional cost (150' of 3/16" aircraft cable is included). This is a job you can probably do yourself, but if you would like us to help you set it up, we simply charge for the amount of shop time required.

Chain Saw Rope Winch

A SIMPSON CAPSTAN ROPE WINCH is a great tool for hauling or dragging. It turns any chain-saw into a rope-pulling machine. Rope isn't as strong as cable, but it is flexible and light-weight. Rope is also usually more readily available and can be knotted or tied, so it has benefits. Also, with a capstan winch, you're not limited to the length of cable a drum will hold, nor do you lose pulling power as the drum fills. A capstan winch doesn't collect cable, so the diameter of a spool of cable doesn't increase and the pull remains constant.



A Simpson winch weighs only nine pounds and easily attaches to most small chainsaw powerheads. Coupled to a 50 cc chain saw engine, the winch will achieve its maximum pull of about 2000 lbs. The price does not include rope or a powerhead.

MADSEN'S PRICE

879⁰⁰

**Not available
at this time**

A 300' roll of 5/16" double braided rope with 4200 lb tensile strength is \$185⁰⁰.



To install a Simpson winch on a chain-saw powerhead, simply remove the cutting attachment from the powerhead and bolt the winch in its place. An adapter and cutter-less chain are supplied to replace the saw's cutter chain and bar. Two wing nuts secure the adapter and saw to the winch. That's all there is to it.



Log Wizard

List Price ~~350⁰⁰~~
MADSEN'S PRICE
295⁰⁰

The LOG WIZARD has ball bearings on the rotor for long life. The knives are standard 3 1/4" planer blades so they are easy to buy from any hardware store or building center.

It comes with a universal spline that can accommodate any pitch sprocket. To install it on a saw, simply fit it up, drill two mounting holes in the bar, and fit up a chain. A slightly longer chain is required to drive the rotor.

The Log Wizard is an excellent farm or construction tool. It can be attached to almost any size or model chain saw. When attached to your saw, it can be used as a debarker, router, notcher, or planer. A Log Wizard is an essential tool for pole barn construction, for fencing, or for log home building. It is unbeatable for smoothing knots or fitting beams. The price does not include the saw, bar, or chain. Made in Canada.







Pro Chain Saw Guide Bars



Listed are our most popular bars for STIHL® and HUSQVARNA® chain saws. Please call if you need a bar that is not listed. These prices reflect our cost at printing time, actual prices may vary. Also, we offer discounts on box quantities. Call for prices and more info.

For Saw Type	Part#	Length	Description	Gauge
  Slot Width: 12.1 mm or .425"	20_RNDD025	20"	Painted Pwr Mtch	.050" or .063"
	24_RNDD025	24"	Painted Pwr Mtch	.050" or .063"
	28_RNDD025	28"	Painted Pwr Mtch	.050" or .063"
	30_RNDD025	30"	Painted Pwr Mtch	.050" or .063"
	32_RNDD025	32"	Painted Pwr Mtch	.050" or .063"
CALL FOR PRICING				
 	343RNDD025	34"	Painted Power Match	.063"
	363RNDD025	36"	Painted Power Match	.063"
	423RNDD025	42"	Painted Power Match	.063"
   	ST-2863	28"	Superbar	.063"
	2863	28"	DuraLite Low Weight	.063"
	ST-3263	32"	Superbar	.063"
	3263	32"	DuraLite Low Weight	.063"
	ST-3463	34"	Superbar	.063"
	ST-3663	36"	Superbar	.063"
	3663	36"	DuraLite Low Weight	.063"
	ST-4163	41"	Superbar	.063"
	ST-5063	50"	Superbar	.063"
	CALL FOR PRICING			

DuraLite bars can fit Huskys by using a small adapter - Call for more info

For Saw Type	Part#	Length	Description	Gauge		
Stihl® 880-090  Slot Width: 14 mm or .553"	SB-3363	33"	Superbar	.063"		
	SB-3663	36"	Superbar	.063"		
	SB-4163	41"	Superbar	.063"	CALL FOR PRICING	
	SB-5063	50"	Superbar	.063"		
	SB-6063	60"	Superbar	.063"		
	SB-7263	72"	Superbar	.063"		
	 SB-8463	84"	Superbar	.063"		
Husky 372-3120  Slot Width: 9.0 mm or .375"	200RNDD009	20"	Painted Power Match	.050"		
	240RNDD009	24"	Painted Pwr Mtch	.050"		
	28_RNDD009	28"	Painted Pwr Mtch	.050" or .063	CALL FOR PRICING	
	300RNDD009	30"	Painted Power Match	.050"		
	32_RNDD009	32"	Painted Pwr Mtch	.050" or .063		
	343RNDD009	34"	Painted Power Match	.063"		
	 363RNDD009	36"	Painted Power Match	.063"		
	423RNDD009	42"	Painted Power Match	.063"		
	   	HU-2863	28"	Superbar	.063"	
		HU-3063	30"	Superbar	.063"	
HU-3263		32"	Superbar	.063"	CALL FOR PRICING	
HU-3463		34"	Superbar	.063"		
HU-3663		36"	Superbar	.063"		
HU-4263		42"	Superbar	.063"		
HU-5063		50"	Superbar	.063"		
HU-6063		60"	Superbar	.063"		
Longer Husky bars are available - Call for more info						

Replacement Sprocket Noses

We carry a full line of REPLACEMENT NOSES for your chain-saw guide bars. Below are our popular sellers. We also carry other brands and types not listed. If you don't see the tip you need, please call. Our actual inventory includes many obsolete and hard-to-find items, too.

Type	Style	Pitch	MADSEN'S PRICE	
			1-5ea	6+ea
		3/8" or .404"	20⁹⁵	19 ⁹⁵
		.3/8" or .404"	21⁹⁵	20 ⁹⁵
		3/8" or .404"	19⁹⁵	18 ⁹⁵
 For Harvester Bar		.404" #SMR14T	29⁹⁵	28 ⁹⁵
 For Harvester Bar		3/4" #40603	105⁹⁵	

Rivets for securing the tip to the bar are included with the replacement tips listed above. If you need extra rivets, let us know. We carry a full inventory of most styles. Please specify the type of bar tip.

Bar Tip Grease Gun



Some bar noses come with lubrication holes. This allows you to grease the nose bearing with a BAR NOSE GREASE GUN. This gun is palm-operated and features a special needle-tip. The gun is filled by packing with a high-quality bearing grease. Item #170-65050.

List Price ~~14⁵⁰~~
MADSEN'S 9²⁵



Small tub of grease (1 lb) **8⁹⁵**

Harvester Bars



We carry a full line of harvester bars to fit popular harvesting machines, including bars not listed here. Call for more information if you don't see the bar you need. Also, call for a quote if you are ordering five or more bars. We offer discounts on purchases of box quantities.

Type	Length	Part #	Link Count	Gauge	Pitch	MADSEN'S
SpeedMax®	19"	592SMRQ104	69	.080	.404	88⁵⁰
SpeedMax®	21"	642SMRQ114	74	.080	.404	91⁵⁰
SpeedMax®	25"	752SMRQ114	85	.080	.404	97⁵⁰
SpeedMax®	25"	752SMRR114	85	.080	.404	97⁵⁰
SpeedMax®	28"	822SMRQ149	93	.080	.404	104⁵⁰
SpeedMax®	28"	822SMRR149	93	.080	.404	104⁵⁰
SpeedMax®	30"	902SMRQ114	104	.080	.404	114⁵⁰
11BC/H		341SNCT138	55	.122	3/4	319⁰⁰
11BC/H		361SNCT146	57	.122	3/4	349⁰⁰
11BC/H		381SNCT043	60	.122	3/4	355⁰⁰
11BC/H		431SNCT043	66	.122	3/4	369⁰⁰

All harvester bars listed have replaceable sprocket noses



Harvester Chain

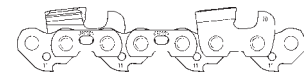

We carry a full line of harvester chain. Call us for a price or if you need a chain not listed here.



Type	Pitch	Gauge	Tooth	Cutter	Sequence	Price#
#11H	3/4"	.122"	micro-chisel	round	standard	<i>Call for a Price</i>
#11BC	3/4"	.122"	chipper	round	standard	
#18H	.404"	.080"	micro	round	standard	
#19H	.404"	.080"	micro	round	standard	

IMPORTANT INFORMATION - WARNING

• All chain listed is for harvesting machines only and should NOT be used on a hand-held chain saw in any conditions. It is too aggressive, has a high-kickback rating, and is too dangerous for hand-held use. This includes experienced professional saw users.



MADSEN'S is the world's largest selling dealer of Oregon® professional square-ground saw chain. This volume allows us to keep the inventory you see on the left. This insures we have what you need, when you need it. Plus, our buying power allows us to offer it at the most competitive prices in the industry.



Chain Loop Pricing. If you prefer to buy chain by the loop, ask about our *two-for-the-price-of-one* deal. With this, you get two loops for one low price. If you need two different chains, that's OK. Just pay the two-for-one price for the most expensive one and get the second one free. We offer this on most saw chain, even harvester chain. Long chains qualify, too. Need a couple chains for your 60" bar? No problem. Just ask for the *two-for-one* deal and save.

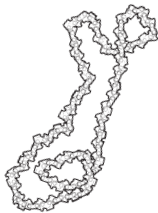

Chain Loops at Bulk Pricing. Buying chain by the roll saves money. However, a problem with buying bulk chain is you may not have the tools or the time for all the cutting and splicing it requires. We can help. If you like bulk prices, but need loops, we will cut them for you from your roll for \$2.50 per loop on most types. We also use a "factory style" spinning tool, so our joints are strong. One thing to remember is when we cut bulk chain into loops, the chain is not returnable, so be sure you know the correct link count your saw requires when you order.

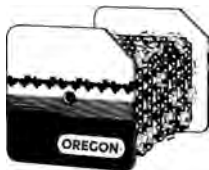

Chain Reel Pricing. We don't print prices in this guide because chain prices fluctuate throughout the year. We always buy aggressively and sometimes get an opportunity to buy chain at a much lower price than usual. When we do, we pass the savings to you. So keep an eye out for our sale flyers in your mail box. Also, watch for our ads in *Logger's World Magazine*. Need to know the price today? Give us a call.... You'll be glad you did.



Service. MADSEN'S specializes in serving the needs of professional chain saw users. We can help you select, maintain, and maximize the performance of your professional saw chain. Need help setting up a grinder? We are here for you. We are chisel-chain experts with decades of experience. We are also available to answer questions about saw chain safety, kickback ratings, and so on. If you need help -- even if it is a hard question -- give us a call or stop in. If we don't have a ready solution, we can get help. We are on a first-name-basis with most of the engineering staff at OREGON Cutting Systems who design and build the chain professional products you use.

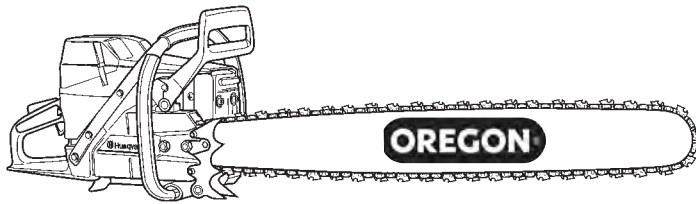

Professional Saw Chain

The chart below is intended to help professional chain saw users select a saw chain that will work well on their professional hand-held chain saw. They are suggestions only. Your specific application may call for something different. Please contact us for more information. Professional saw chain is our business. We can help.

Chain Type	Pitch	Gauge	Tooth Type	Cutter Grind	Chain Configuration	Best Saw Engine Size	Best Saw Bar Length
#91VXL	3/8" Low	.050"	semi-chisel	round	standard	30 to 35cc	14" arborist saw
#95TXL	.325"	.050"	semi-chisel	round	standard	30 to 35cc	14" arborist saw
#20LPX	.325"	.050"	chisel	round	standard	45 to 55cc	16" to 20"
#22LPX	.325"	.063"	chisel	round	standard	45 to 55cc	16" to 20"
#72DPX	3/8"	.050"	semi-chisel	round	standard	65 to 100cc	less than 32"
#72LPX	3/8"	.050"	chisel	round	standard	65 to 100cc	less than 32"
#72EXL	3/8"	.050"	chisel	round	standard	65 to 100cc	less than 32"
#72EXJ	3/8"	.050"	chisel	round	full-skip	65 to 100cc	28" to 36"
#72JPX	3/8"	.050"	chisel	round	full skip	65 to 100cc	28" to 36"
#72CL	3/8"	.050"	chisel	square	standard	65 to 100cc	less than 32"
#72CK	3/8"	.050"	chisel	square	semi-skip	65 to 100cc	less than 32"
#72CJ	3/8"	.050"	chisel	square	full-skip	65 to 100cc	28" to 36"
#75DPX	3/8"	.063"	semi-chisel	round	standard	65 to 100cc	less than 32"
#75EXJ	3/8"	.063"	chisel	round	full-skip	65 to 100cc	28" to 36"
#75CL	3/8"	.063"	chisel	square	standard	65 to 100cc	less than 32"
#75CK	3/8"	.063"	chisel	square	semi-skip	65 to 100cc	28" to 36"
#75CJ	3/8"	.063"	chisel	square	full-skip	65 to 100cc	28" to 36"
#27AX	.404"	.063"	micro-chisel	round	full-skip	80 to 120cc	32" and up"



IMPORTANT INFORMATION - WARNING

- All saw chain listed above should only be used by experienced chain saw professionals with experience and special training for dealing with kickback. Professional saw chain is aggressive and has a high kickback rating. None of it is ANSI approved for use on saws less than 3.8 cubic inches (62 cc).
- Chains and bars designed to minimize kickback are available. These meet ANSI standards and should be used on saws with engines less than 3.8 cubic inches (62 cc) or on any saw that is consumer directed (nonprofessional use). Please contact us for more information.

Chain Breaker

The POCKET CHAIN BREAKER is our least expensive chain breaker. The anvil has a number of slots for accommodating $\frac{1}{4}$ ", low profile $\frac{3}{8}$ ", .325", $\frac{3}{8}$ " and .404" pitch saw chain. The anvil must be used on a solid surface. A hammer is also required. If you have a bench grinder, it is helpful to remove part of the rivet head prior to punching with this tool. This makes it much easier to punch out the rivets.

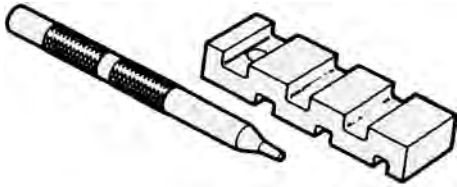

List Price ~~17⁹⁵~~
MADSEN'S 13⁹⁵

Bench Mount Chain Breaker

The BENCH MOUNT CHAIN BREAKER is a shop tool. It works on most sizes of saw-chain from $\frac{1}{4}$ " to .404" pitch. Mount this on your work bench and mark the link counts you cut most often. If you make up a lot of chains or do a lot of repairing, you will wonder how you ever got along without it.

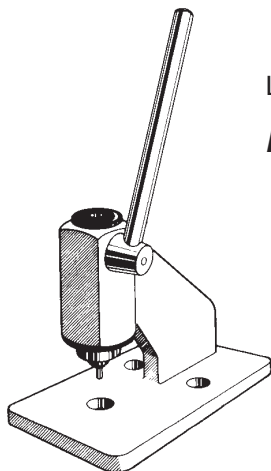

List Price ~~95⁹⁵~~
MADSEN'S 75⁹⁵

Replacement Punch Bit



New Style
7⁸⁵

Item #38594

Depth Gauge Filing Tool

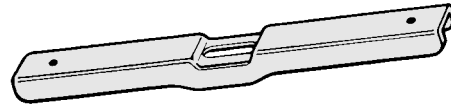

You know how important it is to have a smooth, fast cutting chain. It's also important that the chain cut straight. All of this is impossible if the rakers are not properly maintained.

The PRESET RAKER GAUGE helps you file your rakers to the correct height. It is available in .025" or .030"



List Price ~~4⁷⁵~~
MADSEN'S 3⁸⁵

Bench Mount Rivet Spinner

The BENCH MOUNT RIVET SPINNER is used to join saw chain. The spinner makes a strong joint by shaping rivet heads on pre-set tie straps. Included is the spinning head necessary for riveting most types of $\frac{3}{8}$ " pitch saw chain. Ask about other chain sizes. This, and the bench mount chain breaker shown on the left, make a great team.

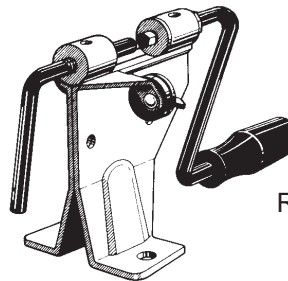

List Price ~~95⁹⁵~~
MADSEN'S 75⁹⁵

Replacement Spinner Bit



New Style
7⁸⁵

Item #38597



Old Style
11⁶⁰

Item #26889

Clamp-on Filing Guide

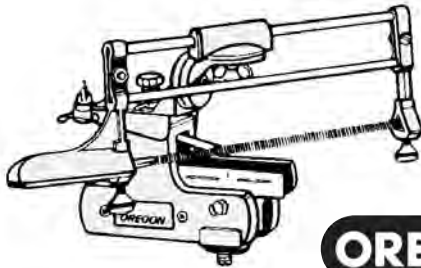

OREGON®

With the PROFESSIONAL FILE GUIDE, you don't have to remove the saw-chain from the bar to sharpen it. This guide clamps on the cutting attachment and accurately holds filing angles you select. It is adjustable on each axis and will fit file sizes from $\frac{5}{32}$ " to $\frac{7}{32}$ ". A file is not included. Item #557849.

List Price ~~55⁷⁰~~
MADSEN'S 41⁹⁵

12 Volt Chain Sharpener

The ELECTRIC SAW CHAIN SHARPENER offers speed and convenience. This 12 volt grinder is meant to be attached to a car, truck, or ATV battery for easy chain sharpening in the field. Bit sizes are available in $\frac{5}{32}$ ", $\frac{3}{16}$ ", $\frac{7}{32}$ ", and $\frac{1}{4}$ ". Item #585015.



OREGON®

List Price ~~50⁰⁰~~
MADSEN'S 39⁹⁹

Round File Guide

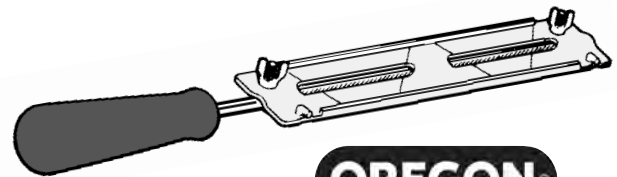

OREGON®

The FILE GUIDE helps maintain sharpening angles when hand-filing. It is especially helpful in keeping the file at the correct height. The guide is good for both a beginner or experienced filer who touches up his chain in the field. Each guide comes with a file. Please specify size when purchasing: $\frac{7}{32}$ ", $\frac{3}{16}$ ", or $\frac{5}{32}$ ".

List Price ~~18²⁰~~
MADSEN'S 13⁹⁵

OREGON®

110v Saw Chain Grinder

The OREGON ELECTRIC SAW CHAIN GRINDER is a round chain grinder built for saw users who sharpen $\frac{1}{4}$ ", $.325$ ", $\frac{3}{8}$ ", and $.404$ " pitch round saw chains. If you are looking to sharpen $\frac{3}{4}$ " pitch harvester chain, contact us for more information. Item #520-120.



List Price ~~899⁰⁰~~
MADSEN'S 499⁰⁰

To stay competitive with online merchants, we offer this at a low in-a-box price, like they offer. However, for an additional \$39.95, we will assemble the grinder and give you up to an hour of personal instruction in our shop on how to use it. This is suggested if you are new to grinding saw chain.

T&S #CS118 3/4" Pitch Harvester Chain Grinder

If you need to replace your old Silvey #P&D grinder or want a new grinder to sharpen the “big” 3/4" saw chain your processor uses, the T&S #CS118 is for you. With the purchase of a separate chain vise and indexing assembly, it can also sharpen .404" harvester chain, such as Oregon #18H & 19H. The T&S grinder is hand-built in Klamath Falls, Oregon.

Features include:

- 8" diameter grinding wheel
- Adjustable cutter-tooth sharpening angles
- 110v variable-speed motor that is fan-cooled
- Reversible direct-drive motor
- Cast aluminum body
- Steel vise rails & stop pawl
- LED flex mounted work light
- Made in the USA
- A work stand is included



MADSEN'S

2149⁰⁰

Simington S451-C Chisel Chain Grinder

The Simington S451-C is a square-chisel chain grinder suitable for both experienced timber fallers or those just breaking-in. The grinder is based on a simple swing-arm design, which makes it easy to use, adjust, and maintain.

This is a time-tested machine. Some grinders, still in use today, have been sharpening square-ground saw chain for over thirty years. Today's S451-C is the newest generation of this popular chisel grinder.

Features include:

- Adjustable cutter-tooth sharpening angles
- Reversible fan-cooled 110v motor
- Carbide-tipped tooth locator
- Two diamond-tipped wheel dressers
- Die-cast aluminum chassis and swing-arm
- Flex-mounted work light
- Three-point adjustable tripod stand included
- Made in U.S.A.

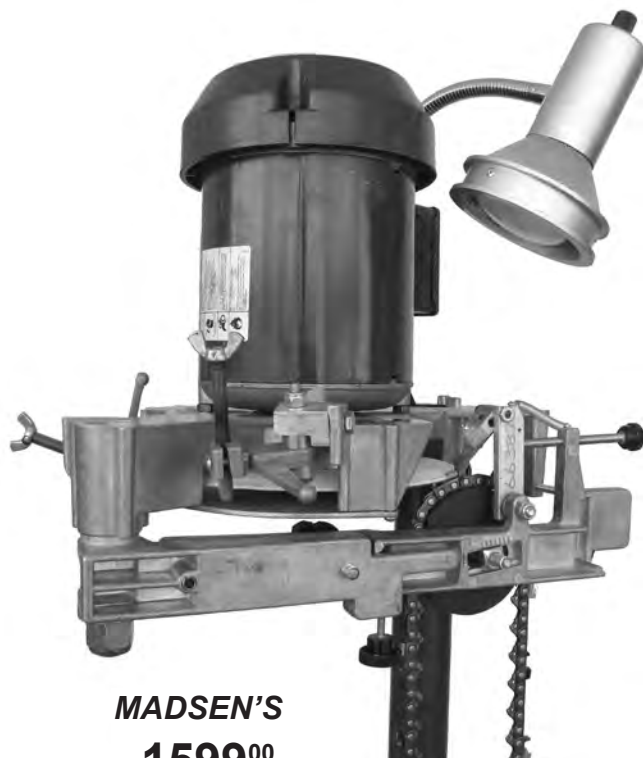

MADSEN'S
1599⁰⁰



Above: Accurate corner alignment is necessary for square-ground cutter-teeth to perform at their peak. The precision necessary for proper alignment is difficult to achieve with a hand file, but easy to achieve using a square-grinder. The mechanism you see above holds the chain in place, while the grinder produces pre-set sharpening angles. This is why most professional saw users sharpen square-chisel chain with a grinder.

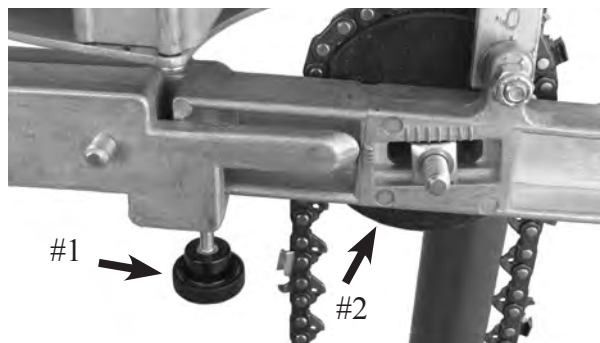

Above: Adjuster #1 changes the grind angle to keep from cutting into the chain's chassis under the hood of the cutter. Adjuster #2 changes the inside side-plate angle by lengthening (or shortening) the arm's swing. Additional angle adjustments can be made by changing the shape of the grinding wheel, which is accomplished by changing the paths of the two diamond dressers, which are also adjustable.



Wheels for Square Chain Grinders

These grinding wheels are for sharpening square-ground chisel saw chain. The descriptions represent the collective opinion of our customers and staff. If your grinder does not have a 1" arbor, see the adapter bushings listed below.

Part	Description	MADSEN'S PRICE	
		1-9 ea	10+ ea

Grinding Wheels for Square-Chisel Saw Chain Grinders:

#M21 -- Fits a Silvey, Simington, and other square-ground chisel grinders -- **19⁹⁵** 17⁹⁵
 8" X 1" X 3/16" This grey-colored wheel dresses easily and removes dull material well, but doesn't hold its shape as well as harder wheels. It is similar to the Silvey #021 grinding wheel, which was standard equipment on Silvey grinders. If you are new to square-grinding, this is a good choice. With regular dressing it is less prone to over-heating cutter-teeth.

#M47 -- Fits a Silvey, Simington, and other square-ground chisel grinders -- **19⁹⁵** 17⁹⁵
 8" X 1" X 3/16" This salmon-colored wheel is similar to what came on Bell chisel grinders. It shapes and finishes cutter-teeth well. It has been around for years, and remains one of our best selling wheels.

#M50 -- Fits a Silvey, Simington, and other square-ground chisel grinders -- **19⁹⁵** 17⁹⁵
 8" X 1" X 3/16" This white-colored shapes and finishes well, plus some users say its white color makes it easier for them to see its corner. This makes it easier to align it with the corner of their chain's cutter-teeth, which is critical for top cutting performance.

#M49 -- Fits a Silvey, Simington, and other square-ground chisel grinders -- **19⁹⁵** 17⁹⁵
 8" X 1" X 3/16" This is a brown resin-bonded wheel made with 80 grit abrasive. It removes dull material with ease, but doesn't finish or shape as well as the other choices. Some also use it on a round grinder, such as the Silvey 510, where it can be used to sharpen round saw chain or for cutting gullets on square-ground chain.

#M99 -- Fits a Silvey, Simington, and other square-ground chisel grinders -- **39⁹⁵** 36⁹⁵
 8" X 1" X 3/16" This blue vitrified wheel is made by blending ceramic and aluminum oxide abrasive. It keeps its shape well and produces good cutter-teeth. Many believe it is the best wheel, but it's expensive. In spite of its price, it is a top-selling grinding wheel.

Grinder Accessories

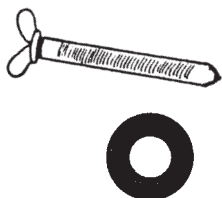

Part Description	List	MADSEN'S
Single-Point Diamond-Tipped Dresser	49 ⁸⁵	39⁵⁰
Grit-Style Diamond-Tipped Dresser	49 ⁸⁵	39⁵⁰
Silicon Carbide Dressing Brick	25 ⁵⁰	18⁹⁵
Reusable 1" to 1/2" Wheel Arbor Adapter	5 ⁵⁰	2⁹⁵



Other Grinding Wheels

Listed below are our best selling grinding wheels, and we carry others. If you need a wheel for a chain grinder not listed, let us know. We can probably help.

Part	Description	MADSEN'S PRICE	
		1-9 ea	10+ ea

Grinding Wheels for Round Saw Chain Grinders:







#M45	-- Fits many round grinders -- 5-1/2" X 1" X 3/16" This is a common-sized wheel works for sharpening most .325", 3/8" and .404" pitch round chain. It has a coarse grit wheel and will remove dull cutter-tooth material with minimal burning.	18⁹⁵	16 ⁹⁵
#M315	-- Fits a Silvey 300 & other round grinders -- 5-3/4" X 1" X 3/16" This is a good wheel for sharpening standard 3/8" saw chain. It is similar to the old Silvey #SG3-15 grinding wheel. We also carry other wheels similar to this in other thicknesses.	18⁹⁵	16 ⁹⁵
#M316	-- Fits an Oregon, Efco, Jolly, or Techomec round grinder -- 5-3/4" X 1" X 3/16" It is the best size for sharpening standard 3/8" chain on these grinders. We also carry similar wheels in other thicknesses: 1/8", 1/4" and 5/16", for sharpening other size chain or for cutting depth-gauges. When ordering, ask us to include a free 7/8" to 1" adapter, which you will need.	18⁹⁵	16 ⁹⁵
#M818	-- Fits a Silvey 510, 600, & other round grinders -- 8" X 1" X 1/8" This is a clone of the old Silvey #021-8R wheel, which is a good size for sharpening 1/4" pitch & low profile 3/8" chain.	18⁹⁵	16 ⁹⁵
#M832	-- Fits a Silvey 510, 600, & other round grinders -- 8" X 1" X 5/32" This is a clone of the old Silvey #021-15R wheel, which is a good size for sharpening .325" & some standard 3/8" chain.	18⁹⁵	16 ⁹⁵
#M55	-- Fits a Silvey 510, 600, & other round grinders -- 8" X 1" X 3/16" This is a good size for sharpening 3/8" or .404" pitch round saw chain. It also works on the Silvey #510-080 grinder, for sharpening .404" harvester chain grinder.	20⁹⁵	18 ⁹⁵
#M516	-- Fits a Silvey P & D grinder -- 8" X 1" X 5/16" A resin bond wheel is for sharpening the big 3/4" pitch pond & deck or harvester chain.	26⁹⁵	23 ⁹⁵
#M85	-- Fits a Silvey P & D grinder -- 8" X 1" X 5/16" A vitrified wheel (similar compound to #M55) for sharpening 3/4" pitch harvester chain.	26⁹⁵	23 ⁹⁵

Grinding Wheels for Bar Rail Grinders:

#BR312	-- Fits a Silvey Bar Rail Grinder -- • This is a 3.5" cupped wheel made especially for the Silvey BRG grinder.	19⁹⁵	17 ⁹⁵
#MA4609B	-- Fits a Bar Shop brand grinder -- • This is a 6" cupped wheel made especially for the Bar Shop brand grinder.	69⁹⁵	61 ⁹⁵

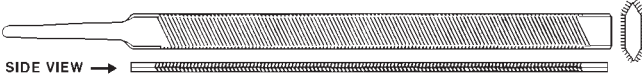
Chain Saw Files

MADSEN'S carries premium files made in Europe. These may cost more, but they deliver excellent value because they cut well and last a long time.

Size - Type - Description	List Price	MADSEN'S PRICE		
		1-11 ea	12-35 ea	36+ ea
5/32", 3/16", 13/64", & 7/32" round chain or gullet files 	3⁹⁹	2⁹⁵	1 ⁸⁵	1 ⁷⁵
5/16" round file for 3/4" pitch (#11BC) P & D or harvester 	10⁹⁵	3⁹⁵	3 ²⁵	2 ⁹⁵
Ribbed plastic file handles that fit most chain files. 	4³⁵	.99	.89	
7" double-bevel chisel chain file 	23⁸⁵	16⁹⁵	15 ²⁵	14 ²⁵
6" premium flat raker or rider file 	6⁵⁰	5⁸⁹	5 ²⁹	4 ⁹⁹
8" flat axe or general purpose file 	9⁴⁰	7¹⁹	6 ⁶⁹	6 ⁰⁹
10" flat axe or general purpose file NOT AVAILABLE AT THIS TIME 	12²⁹	9²⁹	8 ²⁹	7 ⁵⁹

OREGON

Your Questions Answered on Square-Ground Chisel Saw Chain Maintenance

First, thank you for the feedback on the information we published in our last catalog. We appreciate your comments and are grateful you found it helpful. Along with your feedback, we also received some questions. Many were similar, so we compiled them into a follow-up collection you'll find on the following pages. We hope this helps those who didn't contact us. Most questions pertain to how to set up a chisel grinder to produce the angles we recommended. So let's start here.

Q: You say it is best to have a slight back-slope on the outside side-plate angle on my chain's cutter-teeth. If my grinder produces no back-slope, how do I adjust it to produce this?

A: You change the back-slope by changing the shape of your grinding wheel -- and this is done by adjusting the path the outer dresser makes when you dress the wheel. (The outer dresser is the one that makes the "thin" or vertical cut on your grinding wheel.) To change it's path, you adjust the position of the block on which the dresser is mounted. But, before you dive in and make a change, it's a good idea to mark the block's original position. If you end up not liking the change you make, you need to have marks that make it easy to return the block to the "home" setting.

A good way to mark the position of the dresser block is to outline it with a thin felt-tipped marker on the grinder's housing. If you don't like the idea of marking your

grinder's housing with ink, apply a couple pieces of masking tape to the housing. This will allow you to make your marks temporary.

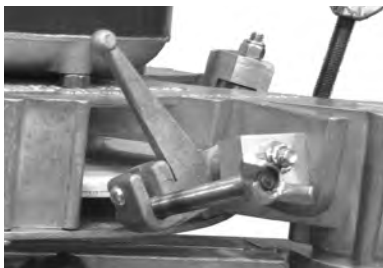

To change the shape of the wheel, you change the path of the dressers by adjusting the position of their mounting blocks.

Once the position of the block is marked, loosen the bolt that holds the block in place. With the bolt loosened, but snug, slightly rotate the block's position so the top of the dresser moves closer to the motor. Then retighten it. When making this change, remember it is best to move in small amounts. It also helps you avoid going past your target shape.

After the block is moved, redress the grinding wheel. Next, mount a test chain and grind a cutter-tooth to test your change. If you like it, keep the change. If you don't, loosen the block, and move it again.

Q: How do I adjust my square-grinder to remove the gullet during sharpening? On new square-ground chain, I can see the factory grinds most of it out. I'd like to set my grinder up to do the same?

A: Unfortunately, there is no adjustment that makes it possible to remove the gullet during sharpening (like the factory does). The reason is: The factory sharpens cutter-teeth before they assemble the chain. They don't have to worry about grinding into the tie-strap under the cutter's hood because when they sharpen it, the tie-strap is not there. If you attempt to adjust your square-chisel grinder to remove the gullet at the same time you sharpen a cutter-tooth, you will end up grinding into the chain's chassis. This damage will weaken the chain and may cause the chain to break.



This brand new cutter-tooth was sharpened at the factory with a grinding wheel wide enough to remove the gullet. You can't set up your grinder to duplicate this grind this because it was ground before the chain was assembled.

Gullets must be removed in a second operation with either a round file or round chain grinder. It is true, some square-grinders can remove more gullet material than others, and we recommend you set yours up to remove the maximum amount, but no grinder we have ever seen is able to remove all of it

at the same time it sharpens. (If you want to learn how to set up your grinder to remove the maximum amount, read on.)

Q: How wide should I make the side of my grinding wheel?

Most of the time the side of the grinding wheel should be about 1/8" thick, but this is just a ballpark measurement. The width that works best on your grinder depends on how your grinder is set up and how tall the cutter-teeth are you are sharpening. So, if your grinder is set up to grind .404" pitch chain, you'll want to run a thicker edge. If you are setting up for 3/8" pitch chain, you'll want it to be thinner. The reason is, .404" chain is taller and this makes it necessary to run more edge-thickness.



The edge of the grinding wheel should be thick enough to sharpen as much of the side of the cutter-tooth as possible without grinding into the chain's chassis under the cutter's hood.

It also makes a difference if the chain's cutter-teeth are new or old. Cutter-teeth are tallest when new and gradually shrink as they are sharpened back. Your goal is to grind with the widest wheel edge possible, but not so wide that you cut into the chain's chassis under the hood of its cutter-teeth.

So when sharpening new chain, the edge of the grinding wheel can be thicker than when you are sharpening it for the last time.

Q: Does it *really* hurt to cut into the chain's tie-straps under the hood of the cutter teeth? It seems like everyone does it.

It's true, there are a lot of users who do this and don't have problems breaking chains because of it. But, we recommend you don't, because it weakens the chain's chassis. If you decide to ignore our advice, be careful. Even a small nick in a tie-strap gives a crack a place to start.



The gullet needs to be removed from this cutter-tooth. Also notice the grinding damage on the drive link and above the rivet on the tie strap.

Q: Why do side-beaks hurt chain performance?

A: A cutter-tooth with a side-beak still has a sharp corner, so it usually cuts well, but its ability to stay sharp will suffer. This is because a beaked corner is fragile. It lacks the support that an aligned corner has. This is why ground chain often stays sharp longer than filed chain. Filers almost always put a small side-beak in the corners of their cutter-teeth. Expert filers know they never want to create a top-beak, so they place the file's corner a little low on purpose.

With a grinder, it is easier to hold and align corners accurately, so you don't have to allow as much for human error as you do when sharpening by hand. This is why ground cutter-teeth (with aligned corners) often stay sharp longer than filed cutters.

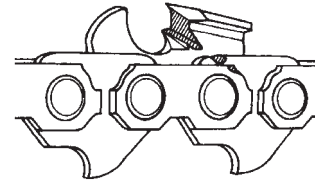

This cutter-tooth has a side-beak. A cutter-tooth with a side-beak can be sharp, but a beaked corner is weak and reduces a cutter-tooth's stay-sharp ability.

Q: Why do all the cutter-teeth on a chain have to be the same length?

A: Some users think it is wasteful to remove any cutter-tooth material that is not dull. They don't set the stops on their grinder and sharpen each tooth as if it was the only one on the chain. This is a mistake.

Since saw chain is a team of cutter-teeth, anything that causes some teeth to take bigger bites of wood than others is not good. First, if the load on each tooth is different, this can cause vibration. Second, if the total amount of wood removed by right-side cutter-teeth is different from the total removed by those on the left, cuts will pull in the direction of the side that removes the most wood. For a chain to cut smooth and straight, each tooth must remove the same amount of wood.

Pro Saw Performance Tips

If you are sharpening a rocked chain, start the process by sharpening the duller cutter-teeth first. Then, match the rest of the cutters to that length. This may mean removing more cutter material than you'd like, but it's necessary if you want a smooth and fast cutting chain.

If you are sharpening with a file, getting all the teeth the same length is difficult. Some people use a micrometer to measure each tooth, but this is tedious. One of the benefits of using a grinder is this is easy to do. All you have to do is set the feed stops and grind each cutter-tooth to them. It's that simple.

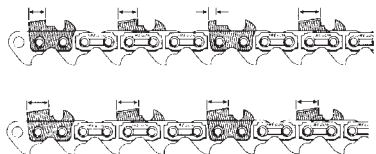

This upper graphic shows cutter-teeth of different lengths. The lower graphic shows teeth of the same length, which is necessary for smooth cutting saw chain.

Q: How do I keep from overheating cutter teeth when I grind them?

A: There are several things a grinder operator can do to keep heat under control. The first is to remove dull material from cutter-teeth in small amounts. When feeding the grinder, slowly pulse the feed arm, letting the tooth cool between feeds. This strategy is much like pumping the brakes on your truck while descending a long hill with a load.

Another practice that aids in keeping cutter-teeth cool is to frequently dress the grinding wheel. The abrasive on the surface of a grinding wheel gets contaminated and dull with use. That dark ring you see on grinding wheels tells you the wheel needs to be dressed. This cleans the wheel surface and exposes a fresh layer of sharp abrasive. Frequent dressing also helps restore the grinding wheel's shape, and especially its corner. (A crisp corner in your grinding wheel makes for a sharp working corner in your chain's cutter-teeth.)

If you have a chain with a lot of damage, another way to manage heat is to remove the dull material in two or more passes. Set your grinder to remove half the damage in the first pass, then remove the rest in a second or third pass. This allows time for teeth to cool between passes. There is also a psychological benefit to removing damage incrementally.

If you are sharpening in a shop and compressed air is available, another secret to keeping teeth cool during grinding is to blow a small amount of compressed air on the surface of the tooth you are grinding. This extra air carries away some of the heat and can help speed up the sharpening of "rocked" cutter-teeth.

One factor all operators of square-grinders must face is that grinding wheels used for sharpening square-ground chain tend to have finer grit than those used on round grinders. This contributes to the heating problem. Wheels typically used on round grinders are

usually made of coarser abrasive. This abrasive removes damage more quickly without heating up cutter-teeth, but it doesn't produce as good of a shape or final finish.

Q: Are cutter-teeth chrome plated to make them look good or does the chrome have some other purpose?

A: The shiny silver metal coating on the outside of a cutter-tooth is chrome. It is true, chrome does make cutter-teeth look good, but it is not there for cosmetic reasons. Chrome is a hard material that produces a "crust" on the surface of cutter-teeth that is harder than the steel they are formed of. This chrome crust reinforces a cutter-tooth's corner, making it more durable. This enhances a chain's stay-sharp ability. Today, all professional saw chain is chrome plated.



This is a photo of a cross-section of the sharp point of a cutter-tooth taken with an electron microscope. The top layer you see is chrome plating. The material under it is steel. Notice how the plating reinforces the sharp steel edge.

Q: Sharpening each cutter-tooth back into clean chrome also seems wasteful. Why do I have to sharpen back so far?

A: One mistake some pro saw users make is they don't remove all the damage from their chain's cutter-teeth when they sharpen. They don't realize a tooth's sharp edges need to be ground back to where it is protected by undamaged chrome plating. When a chain is severely dull, this means it is often necessary to remove a lot of material.

Q: When you sharpen square-ground chain with a file, should the file cut going into the tooth or out of it?

A: The short answer is: Either direction is acceptable. However, you might want to learn a little more before you decide what is right for you.

You just learned cutter-teeth are chrome plated to reinforce their sharp edges. This significantly adds to their stay-sharp-ability. Unfortunately, chrome also makes cutter-teeth more difficult to sharpen - especially with a file.

When you file going into a cutter-tooth, the file must first cut through chrome before it removes steel. Files can do this, but they become dull as bits of hard chrome are driven into their teeth. When you file going out-of the tooth, the last thing the file hits is chrome. This tends to be easier on the file. The result is a file will last longer when you sharpen going out of the tooth. The problem is, when sharpening square-ground chain with a file, it is easier to align the corners with the file going into the tooth. So although this is hardest on a file, it is the way most people sharpen.

When using a grinder to sharpen, chrome is less of a chal-

lenge. Operators always want the wheel to cut going into the tooth. This breaks the chrome cleanly and places any grinding burr under the hood of the cutter-tooth.

Q: Are filed teeth or ground teeth sharper?

A: This question has been debated in crew busses for years. The truth is, sharpening with a file can be just as effective as sharpening with a grinder. This is especially true with round-filing. There are a lot of people who sharpen very well with a round file. Unfortunately, the same is not true when it comes to square-filing. Very few people square-file well. So with square-ground chain, the question about "sharpness" is really more about corner alignment and accuracy. And, for most users, this is easier to achieve with a square-grinder.



When filing square-ground chisel chain, the direction we recommend is to cut going into the cutter-tooth.

Q: How much better does square-ground saw chain really perform?

A: Square-ground chain is not better in every way, but it is the most efficient. What this means is square-ground chisel chain requires less power to sever wood fiber than other styles. This offers pro saw users some advantages and here are the facts: Square-tooth

saw chain (that is round ground) is ten to fifteen percent more efficient than round-tooth chipper chain. And square-ground chain is about ten percent better than that. So, as compared to round-tooth chain, square-ground chisel chain is roughly twenty percent more efficient. On a hand-held chain saw, this is a big deal, because power is usually a limiting factor. With more efficient saw chain, a chain saw cuts faster and a user can run a longer bar without the need to run a larger (heavier) and more powerful power-head.

Square-ground chain's extra efficiency does not come without costs. For one, it is more difficult to maintain. Not only are its cutter-teeth more difficult to sharpen, but its maintenance requires more processes. When round-tooth chain is sharpened, gullet removal happens at the same time round-tooth chain is sharpened. With square-ground chain, gullet removal requires a second operation.

Less stay-sharp-ability is another significant disadvantage. Square-ground chisel chain has fragile cutting edges compared to round-tooth saw chain. This is why you don't see square-ground chain used on mechanized harvesters. These machines have diesel engines with ample power. For them, stay-sharp ability is more important than cutting-efficiency.

When it comes to hand-held pro saws, its performance benefits are why square-ground is so widely used by loggers and timber fallers in the Western US, and Alaska. Interestingly, it is not

Pro Saw Performance Tips

common in other parts of the world. Part of the reason is, in this region we cut mostly large soft-wood trees. This wood is not as hard and/or gritty as the hardwood commonly cut in other areas. Here, square-ground chisel chain's stay-sharp-ability is not as much of a disadvantage as it is in those regions. Also, our large trees are regularly harvested growing on steep slopes. These slopes make harvesting difficult even with light-weight chain saws, so the benefit of being able to utilize long guide bars on a medium-sized power-head is substantial.

Q: Why does the first half of the chain perform better than the last half?

A: The reason is: The chain's cutter-teeth are their tallest and widest when they are new. Each time it is sharpened, it's cutter-teeth are ground (or filed) back. As cutter tooth become shorter, they loose both height and set. This reduces the chain's cutting capacity.

In theory, saw chain can be used as long as its cutter-teeth can be sharpened. But in reality, most square-ground saw chain is not used this long. A chain's best cutting performance is in the first half of its life. There are no sharpening secrets that will make an old chain perform as well as a new one.

Q: What is the single most important factor that affects the performance of square-ground saw chain for most pro saw users?

A: The answer is: corner alignment. If your sharpening and maintenance program gets you close to what we say, your chain

will perform well. This is not the case with corner alignment. It has to be perfect. If your alignment is off (especially if high), your chain won't cut well. If you remember only one fact from all you just read, remember this! It is truly the secret to top performing square-ground saw chain.

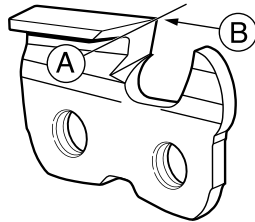

The corner of your grinding wheel (plane A) must be aligned with the outside corner of the cutter-tooth (point B). This is the most important factor in getting top performance from square-ground chisel saw chain.

We often see users who don't realize they need help seeing up close. You may only be forty years old (and have many sawing years ahead), but your days of seeing fine details without aid may have passed. When you sharpen cutter-teeth, you must be able to see well. If you've run a pro saw for many years, you may not realize (or admit) how hard it has become to see the corners on your saw chain. More than one pro user's chain problems have been solved with a good pair of "see-up-close" safety-glasses. Off-the-shelf safety glasses with built-in bifocals are an inexpensive and effective solution.

Another key to seeing the corners is using plenty of light and having it directed in the right place. One light trick that works

for grinder operators of any age is adjusting the work-lamp so the edge of the grinding wheel is shadowed. This helps makes the corner of the grinding wheel more visible and makes it easier to align it with the corner of each cutter-tooth.



Position your grinder's work light so the corner on the grinding wheel and the corner of cutter-tooth you are sharpening is clearly visible.

Conclusion

Now you know even more about the processes involved in maintaining square-ground chisel saw chain. We hope this additional information helps you produce the best cutting saw chain you have ever used. We thank the engineers at Oregon Cutting Systems, especially Mike Harfst, Jerry Locker, and Randy Jensen, for providing many of the graphics on the previous pages and for reviewing its contents.

For more information, see our web site. If you have questions or need help tuning your grinder, please come in or call us. We are here for you... that's why we're the Pro's Choice.

OREGON Quality Pro
Saw Chain

Madsen's Shop & Supply Inc
1408 South Gold #2
Centralia WA 98531

Prst Std
US Postage
PAID
Spokane WA
Permit 7

Satisfied Customers Say:

- "... You guys are the B-E-S-T." Elma, Washington
- "I am extremely grateful for all of your time and advice." Lake Odessa, Michigan
- "Just a short note to say thanks to Madsen's and crew for always prompt service." Curlew, Washington
- "Thank you for accommodating my purchase. Appreciate it." Rouge River, Oregon
- "Your service and advice is worth more than money." Canterbury, Connecticut
- "I just want you to know that we very much appreciate you all at Madsen's. I started going to Madsen's in the 80's and have always been very pleased with the customer service, availability, and prices..." Shelton, Washington
- "I've been a customer of Madsen's for 35 years. You guys are on top of it." Cottage Grove, Oregon
- This is a letter of appreciation for the excellent service provided on my first visit to Madsen's... Trust and competence are essential for customers to bond. I will always come back to Madsen's. I am also telling my friends. Superb service deserves to be acknowledged..." Olympia. Washington

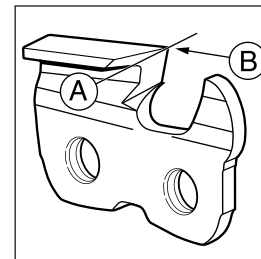

***Inside: See How to Get Top Performance
From Professional Square-Ground Chain***

Phone
360-736-1336
Order Line
800-822-2808
Fax
360-736-9522
Web Site
www.madsens1.com

